

## إقرار

أنا الموقع أدناه مقدم الرسالة التي تحمل العنوان:

### Developing A New Fast And Reliable Handoff Approach In Wireless Networks

أقر بأن ما اشتملت عليه هذه الرسالة إنما هو نتاج جهدي الخاص، باستثناء ما تمت الإشارة إليه  
حيثما ورد، وإن هذه الرسالة ككل أو أي جزء منها لم يقدم من قبل لنيل درجة أو لقب علمي أو  
بحثي لدى أي مؤسسة تعليمية أو بحثية أخرى.

#### DECLARATION

The work provided in this thesis, unless otherwise referenced, is the  
researcher's own work, and has not been submitted elsewhere for any  
other degree or qualification

Student's name:

اسم الطالب/ة: إبراهيم محمد أبو مطلق

Signature:

التوقيع: 

Date:

التاريخ: 2016 / 01 / 30

**The Islamic University of Gaza  
Deanery of Higher Studies  
Faculty of Engineering  
Computer Engineering Department**



## **Developing A New Fast And Reliable Handoff Approach In Wireless Networks**

**Submitted by:**

**Ibrahim M. Abu Mutlag**

**Supervisor :**

**Dr. Aiman A. Abu Samra**

A Thesis Submitted in Partial Fulfillment of the Requirements  
for the Degree of Master of Science in Computer Engineering

**Gaza, Palestine**

**( 2015 AD , 1437 AH )**



## نتيجة الحكم على أطروحة ماجستير

بناءً على موافقة شئون البحث العلمي والدراسات العليا بالجامعة الإسلامية بغزة على تشكيل لجنة الحكم على أطروحة الباحث/ إبراهيم محمد إبراهيم أبو مطلق لنيل درجة الماجستير في كلية الهندسة قسم هندسة الحاسوب وموضوعها:

### تطوير نهج التحول الجديد سريع وموصوف بأشبكات اللاسلكية

#### Developing A New Fast And Reliable Handoff Approach In Wireless Networks

وبعد المناقشة التي تمت اليوم الثلاثاء 11 ربيع الأول 1437هـ، الموافق 2015/12/22م الساعة الحادية عشرة والنصف ظهراً، اجتمعت لجنة الحكم على الأطروحة والمكونة من:

.....	مشرفاً و رئيساً	د. أيمن أحمد أبو سمرة
.....	مناقشاً داخلياً	أ.د. محمد أمين مكي
.....	مناقشاً خارجياً	د. حسن نجيب قنوع

وبعد المداولة أوصت اللجنة بمنح الباحث درجة الماجستير في كلية الهندسة / قسم وموضوعها: هندسة الحاسوب.

واللجنة إذ تمنحه هذه الدرجة فإنها توصيه بتقوى الله ولزوم طاعته وأن يسخر علمه في خدمة دينه ووطنه.

والله ولي التوفيق ،،،

نائب الرئيس لشئون البحث العلمي والدراسات العليا

أ.د. عبد الرؤوف علي المناعمة

## **ACKNOWLEDGMENT**

**All thanks to those who have contributed to made this thesis possible.**

**My thankfulness to my supervisor Dr. Aiman Abu Samra , without his support , this thesis would have never been possible.**

## **DEDICATION**

**To the souls of my parents ...**

**To my wife and my sons ...**

**To my brothers and sisters ...**

**To all my friends ...**

**And to my beautiful university "Islamic University –Gaza"**

## **TABLE OF CONTENTS**

<b>ACKNOWLEDGMENT</b> .....	iii
<b>DEDICATION</b> .....	iii
<b>TABLE OF CONTENTS</b> .....	iii
<b>LIST OF FIGURES</b> .....	iii
<b>LIST OF TABLES</b> .....	iii
<b>ABSTRACT</b> .....	iii
<b>ARABIC ABSTRACT</b> .....	iii
<b>Chapter One : Introduction</b> .....	2
<b>1.1 Overview</b> .....	3
<b>1.2 Problem Statement</b> .....	3
<b>1.3 Thesis Contribution</b> .....	4
<b>1.4 Wireless Local Area Network Overview</b> .....	4
1.4.1 <b>Types Of Operational Modes Of The 802.11 Specification</b> .....	5
1.4.2 <b>802.11 Protocol</b> .....	5
1.4.3 <b>IEEE 802.11 Medium Access Control (MAC) Sub Layer</b> .....	7
<b>1.5 Roaming In IEEE 802.11</b> .....	8
<b>1.6 Location And Handover Management In WLAN</b> .....	9
<b>1.7 Types Of Handoff</b> .....	10
1.7.1 <b>Horizontal Versus Vertical Handoffs</b> .....	10
1.7.2 <b>Low Latency Handoff Schemes</b> .....	12
1.7.3 <b>802.11 Handoff Process</b> .....	12
1.7.3.1 <b>Handover Procedure</b> .....	13
1.7.4 <b>Handover Management</b> .....	17
<b>1.8 Fast Handoff</b> .....	17

1.8.1	<b>Fast-handoff Mechanism</b> .....	18
<b>Chapter Two : Related work</b> .....		20
2.1	<b>Introduction to related work</b> .....	21
2.2	<b>Classification Method Of Related Work</b> .....	22
2.2.1	<b>Discovery Method</b> .....	22
2.2.2	<b>Adaptive Method</b> .....	26
2.2.3	<b>Fast Method</b> .....	26
2.2.4	<b>Predictive Method</b> .....	27
2.2.5	<b>Neighboring Method</b> .....	27
2.2.6	<b>Triggering Method</b> .....	28
<b>Chapter Three : Proposed Approach</b> .....		31
3.1	<b>Introduction</b> .....	32
3.1.1	<b>Packets Reception Power Threshold</b> .....	32
3.1.2	<b>Tools Used</b> .....	33
3.2	<b>Proposed Fast Handoff Solution</b> .....	33
3.2.1	<b>Steps For Proposed Fast Handoff</b> .....	34
3.2.2	<b>Location by GPS</b> .....	36
3.2.3	<b>Triggering With Packets Reception Power Threshold</b> .....	37
3.2.4	<b>Mapping Table</b> .....	37
<b>Chapter Four : Simulation And Results</b> .....		38
4.1	<b>Important Attributes Changed for each Node</b> .....	39
4.2	<b>Scenarios Configuration</b> .....	42
4.2.1	<b>VoIP Scenario</b> .....	43
4.2.1.1	<b>Parameter of VoIP QoS</b> .....	43

4.2.1.2	<b>Simulation Parameters</b> .....	44
4.2.2	<b>HTTP scenario</b> .....	46
4.2.3	<b>Case Study : Extended Scenario</b> .....	47
<b>4.3</b>	<b>Results And Discussions</b> .....	49
4.3.1	<b>Scenario 1: VoIP Scenario Analysis</b> .....	49
4.3.2	<b>Scenario 2 : HTTP Scenario Analysis</b> .....	56
4.3.3	<b>Scenario 3 : Extended large Scenario Analysis</b> .....	58
<b>4.4</b>	<b>Comparisons with other works</b> .....	58
	<b>Conclusion And Future Work</b> .....	60
	<b>References</b> .....	63



## **LIST OF FIGURES**

<b>Figure 1.1: Ad Hoc mode of 802.11 specification</b> .....	6
<b>Figure 1.2: Infrastructure mode of 802.11 specification</b> .....	6
<b>Figure 1.3: Architecture of a BSS with two access points</b> .....	7
<b>Figure 1.4: Roaming process in IEEE 802.11</b> .....	8
<b>Figure 1.5: (a ) Horizontal handoff vs. (b) Vertical handoff</b> .....	11
<b>Figure 1.6: Involved elements in layer 2 handover</b> .....	13
<b>Figure 1.7: Passive scanning of the discovery process</b> .....	13
<b>Figure 1.8: Active scanning of the discovery process</b> .....	14
<b>Figure 1.9: Total delay in active scanning of the discovery process</b> .....	14
<b>Figure 1.10: Steps in the re-association process</b> .....	15
<b>Figure 1.11: IEEE 802.11 Handover Procedure</b> .....	16
<b>Figure 1.12: Fast handoff message interaction</b> .....	19
<b>Figure 3.1: Flow chart for our proposed algorithm Fast Handoff Decision</b> .....	35
<b>Figure 3.2: Snapshot of access point signal strength in IUG-University campus</b>	36
<b>Figure 4.1: WLAN access point node model</b> .....	39
<b>Figure 4.2: WLAN workstation node model</b> .....	40
<b>Figure 4.3: The WLAN station node model</b> .....	41
<b>Figure 4.4: Application definition</b> .....	42
<b>Figure 4.5 : VoIP scenario</b> .....	44
<b>Figure 4.6: (Voice) Table</b> .....	45
<b>Figure 4.7: Profile definition (VoIP)</b> .....	45

<b>Figure 4.8: HTTP scenario</b> .....	47
<b>Figure 4.9: Extended scenario which contains 16 Aps on four floors</b> ...	48
<b>Figure 4.10: Extended scenario which contains 16 APs on four floors and 140 Mobile</b>	48
<b>Figure 4.11: Wireless LAN access points connectivity</b> .....	50
<b>Figure 4.12: Wireless LAN delay in sec without proposed approach</b> .....	51
<b>Figure 4.13: Wireless LAN delay in sec using proposed approach</b> .....	51
<b>Figure 4.14: Wireless LAN throughput (bits/sec) with big handoff</b> .....	52
<b>Figure 4.15: Wireless LAN throughput (bits/sec) with proposed Approach</b> .....	53
<b>Figure 4.16: Average (in Voice Jitter ) sec</b> .....	53
<b>Figure 4.17: Average (in Voice Packet End to End delay) sec</b> .....	53
<b>Figure 4.18: Average (in Voice Packet Delay Variation )</b> .....	55
<b>Figure 4.19: Average (in Voice MOS Value )</b> .....	55
<b>Figure 4.20: Wireless LAN Connectivity of Mobile in HTTP Scenario</b> ....	56
<b>Figure 4.21: Wireless LAN Delay In Sec, In HTTP Scenario</b> .....	57
<b>Figure 4.22: Wireless LAN Throughput (bits/sec) In HTTP Scenario</b> ....	57
<b>Figure 4.23: Average (in Wireless LAN Delay) In Extended large Scenario</b> .....	58
<b>Figure 4.24: Comparison of Handoff Latency of the proposed algorithm with other algorithms in related work in Chapter Two</b>	59

## **LIST OF TABLES**

<b>Table 2.1 : Some of related work , handoff algorithms classification and its Behavior</b>	<b>21</b>
<b>Table 3.1 : Parameters of WLAN access point node model .....</b>	<b>40</b>
<b>Table 4.2 : Parameters of mobile workstation node model configurations</b>	<b>41</b>
<b>Table 4.3 : Simulation parameters used in VoIP scenario .....</b>	<b>44</b>
<b>Table 4.4 : Different handoff for VoIP scenario .....</b>	<b>52</b>

## **ABSTRACT**

Signal power of wireless networks is limited to an effective range of only a few hundred meters. A user Alice uses VoIP application or any other real time application, and moves from one access point to another access point, which is outside of the range of the first one. That will result a huge delay in handoff period. This is an actual problem in wireless networks.

This thesis aims to develop and implement a new fast and reliable handoff approach over 8.02.11g that maintains continuity of connection and guarantees quality of service ( Qos ) in WLAN. In order to maintain that, the handoff latency should be minimized. We propose a handoff approach, which takes decision of handoff based on triggering the packets reception power threshold value of the mobile. When Received Signal Power of the current access point is weaker , then localize the nearest access point in its range and decreasing packets reception power threshold then increasing the ground speed of mobile until connected with the selected access point.

We used Opnet 14.5 network simulation to evaluate the performance of the new approach and performance metrics of Qos of VoIP . Simulations have been done to show the importance of taking these parameters into account for handoff decision to reduce handoff delay .

The results of our fast handoff decision approach show the handoff delay is minimized and performance evaluations through simulation experiments achieved the guarantee of quality of service in VoIP.

**Keywords :** Wireless signal power , Handoff Latency , Quality of service , VoIP , Packets Reception Power Threshold.

## ARABIC ABSTRACT

المدي الفعال لقوة الإشارة في الشبكات اللاسلكية محدد فقط بمئات الامتار. المستخدم اليس يستخدم تطبيقات الصوت او غيرها من التطبيقات الأخرى ويتنقل من نقطة الوصول A الي نقطة الوصول B ، حيث ان نقطة الوصول B تقع خارج نطاق نقطة الوصول A ، نلاحظ ان هناك وقت تأخير كبير خلال فترة التحول، وهذه تعتبر مشكلة حقيقة في الشبكات اللاسلكية .

تهدف هذه الاطروحة لتطوير وتنفيذ نهج جديد سريع وموثوق لعملية التحول علي IEEE 802.11g. للحفاظ علي استمرارية الاتصال بالشبكة وضمان جودة الخدمة في الشبكة اللاسلكية. لذلك ينبغي ان يتم تقليل وقت التحول . نهج التحول المقترح يأخذ بالأساس قوة الإشارة المستقبلية من نقطة الوصول الحالية فعندما تصبح ضعيفة اقل من المطلوب. ففي هذه الحالة يتم تحديد اقرب نقطة وصول جديدة ويتم تقليص قوة اشارة الموبايل وزيادة في السرعة الارضية للموبايل حتي يتم الاتصال بنقطة الوصول المختارة.

لقد استخدمنا محاكي الشبكات اوبنت 14.5 لتقييم اداء النهج المقترح ومقاييس الجودة المختلفة. وتم القيام بذلك لإظهار مدي اهمية هذه المعايير في تقليل التأخير في قرار نهج التحول.

ولقد اظهرت النتائج لهذا النهج تقليل وقت التأخير ، وكذلك اظهرت نتائج تقييم الأداء من خلال تجارب المحاكاة ضمان الجودة لخدمة الاتصالات عبر بروتوكول الانترنت.

# Chapter One

# Introduction

## 1.1 Overview

In recent years , wireless technologies are rapidly emerging as an important medium to send and receive data: text, voice and video, and they sometimes serve a large coverage area. Wireless Local Area Networks (Wireless LAN) [1], Wireless Metropolitan Area Networks (Wireless MAN) [2] and Wireless Wide Area Networks (Wireless WAN) [3] are standardized to provide high-rate, high-quality, and high capacity multimedia services in different geographic areas.

Wireless LAN is suitable for small area in small companies. Wireless MAN is applicable for an entire city. Wireless WAN is optimized for a nationwide range. International organizations are actively standardizing these systems. For instance, IEEE 802.11 for Wireless LAN, IEEE 802.16 (or WiMAX) for Wireless MAN, and Universal Mobile Telecommunications System (UMTS) for Wireless WAN and third-generation (3G). Although different technologies may have a substantial difference in architectures and protocols, handoff is always an essential procedure in guaranteeing the continuous, efficient, and resilient services during a Mobile Station (MS) mobility.

## 1.2 Problem Statement

When a mobile roams between wireless access points in WLAN, a horizontal handoff occurs which resulting in a handoff delay and sometimes a disconnection of network . The handoff delay affects QoS of applications which is important especially for VoIP and other real time applications.

The process of deciding and executing a horizontal handoff can be divided into three phases: discovery , re-authentication and re-association. At first the mobile should search and find new available access points. Then should select the strongest received signal from all access points. Finally the mobile re-associate with the best access point.

Our main work of this thesis is how to implement a horizontal handoff and reduce the resulted handoff latency.

### 1.3 Thesis Contribution

The aim of this thesis is to propose a new fast handoff decision algorithm to reduce latency resulting from mobile roaming in WLAN and to guarantee QoS. We study some parameters of mobile and their affected on real-time traffic as VoIP and non-real-time traffic as HTTP when handoff occurs.

We used three scenarios to simulate the performance of two different application types classified by the transport layer. We used the OPNET 14.5 network simulation to evaluate the performance of our algorithm.

We analyze wireless network handoff delay on Islamic University-Gaza (IUG) campus as a case study by simulating on OPNET 14.5.

### 1.4 Wireless Local Area Network Overview

WLAN provides a wireless way to access the Internet, as LAN does through a wired way. WLAN standards are specified by the Institute of Electrical and Electronics Engineers (IEEE). Currently there are three standard versions for WLAN, 802.11a, 802.11b and 802.11g [4]. Among them the most mature one is 802.11b which operates at the frequency band of 2.4GHz with a maximum throughput of 11 Mbps. 802.11g is an upgraded version of 802.11b. It operates at the same frequency band as 802.11b with an improved throughput. 802.11a operates at 5.4 GHz with a maximum throughput of 54 Mbps.

Operators with cellular network could add WLAN as an additional service, enabling them to provide their customers with the access possibilities especially for the areas where there is a high density of users [5]. Log-linear path loss propagation model with shadow fading is given by :

$$PL = L + 10 n \log(d) + S \quad (1)$$

where L is constant power loss, n is path loss exponent with values between 2 to 4, d represents the distance between the mobile node and WLAN access point (AP) and S represents shadow fading which is modeled as Gaussian with mean  $\mu=0$  and standard deviation  $\sigma$  with values between 6-12 dB (decibel) depending on the environment.

The received signal strength for WLAN is expressed in dBm (decibel-milliwatts) as

$$PW = Pt - PL \quad (2)$$



where,  $P_r$  is received signal strength of WLAN in dBm ,  $P_t$  is the transmitted power, When received signal strength is a certain interface sensitivity level the mobile terminal is unable to communicate with the AP.

#### **1.4.1 Types Of Operational Modes Of The 802.11 Specification**

The 802.11 specification defines two types of operational modes:

1. Ad hoc (peer-to-peer) mode
2. Infrastructure mode.

In ad hoc mode also known as Independent Basic Service Set (IBSS), the wireless network is relatively simple and consists of 802.11 network interface cards (NICs). The networked computers communicate directly with one another without the use of an access point as shown in figure 1.1.

In infrastructure mode, the wireless network is composed of a wireless access point(s) and 802.11 network interface cards (NICs). The access point acts as a base station in an 802.11 network and all communications from all of the wireless clients go through the access point. The access point also provides for increased wireless range, growth of the number of wireless users, and additional network security.

A basic wireless infrastructure with a single access point is called a Basic Service Set (BSS). When more than one access point is connected to a network to form a single sub-network, it is called an Extended Service Set (ESS) as shown in figure 1.2.

#### **1.4.2 IEEE 802.11 Protocol**

The IEEE 802.11 standard [1] defines the protocol and compatible interconnections of data communication equipment via the “air” (radio or infrared) in a local area network (LAN). It encompasses the physical (PHY) and the media access control (MAC) layers of the OSI seven-layer network model.

Most installations are of the infrastructure variety. From the point of view of the Ethernet network, which is usually connected to both ends of an 802.11 link, the wireless link is just another way of moving an Ethernet packet, formally known as a frame, from one station to another.

A BSS has a unique identifier, the BSSID. An ESS also has an identifier, the ESSID, that is unique to that ESS but shared by all the component BSSs [6]. Unfortunately, interfaces for many commercial 802.11 implementations use the nomenclature SSID, which in practice usually refers to the SSID but is obviously somewhat ambiguous and potentially confusing. The ESS architecture provides a framework in which to deal with the problem of mobile stations roaming from one BSS to another in the same ESS. It would obviously be nice if a mobile station could be carried from the coverage area of one access point (i.e., one BSS) to that of another without having to go through a laborious process of re-authenticating, or worse, obtaining a new Internet protocol (IP) address; ideally, data transfers could continue seamlessly as the user moved.

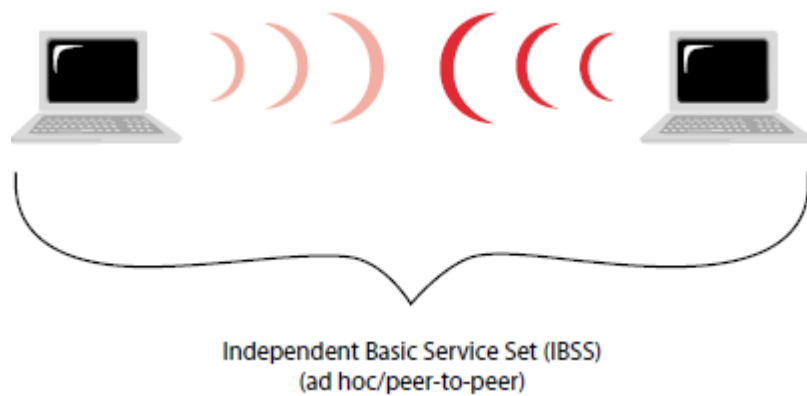

**Figure 1.1: Ad Hoc mode of 802.11 specification**

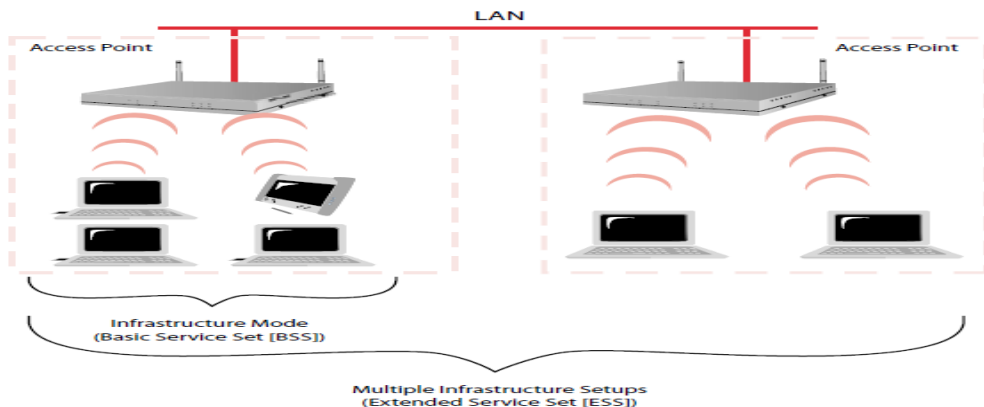

**Figure 1.2: Infrastructure mode of 802.11 specification**

A distribution system is assigned responsibility for keeping track of which stations are in which BSSs and routing their packets appropriately. However, the original and enhanced 802.11 standards did not specify how such roaming ought to be conducted; only with the release of the 802.11f Inter-Access Point Protocol (IAPP) standard in 2003 did the operation of the distribution system receive a nonproprietary specification. The IAPP protocol uses the nearly universal internet protocol (TCP/IP) combined with RADIUS servers to provide secure communication between access points, so that moving clients can re-associate and expect to receive forwarded packets from the distribution system[6].

### 1.4.3 IEEE 802.11 Medium Access Control (MAC) Sub Layer

The media access control of WLAN architecture, is shown in figure 1.3 .The IEEE 802.11 MAC sub-layer defines two relative medium access coordination functions, the Distributed Coordination Function (DCF) and the optional Point Coordination Function (PCF). The transmission medium can operate both in contention mode (DCF) and contention-free mode (PCF). DCF is based on the Carrier Sense Multiple Access with Collision Avoidance (CSMA/CA) protocol, and should be implemented in all stations and APs. Because a sender cannot transmit and listen for noise burst at the same time .

The PCF ,on the other hand, uses a centralized polling approach, which requires an AP to act as a Point Coordinator (PC). The AP periodically polls stations to give them the transmission opportunity (TXOP) to transmit their packets[7].

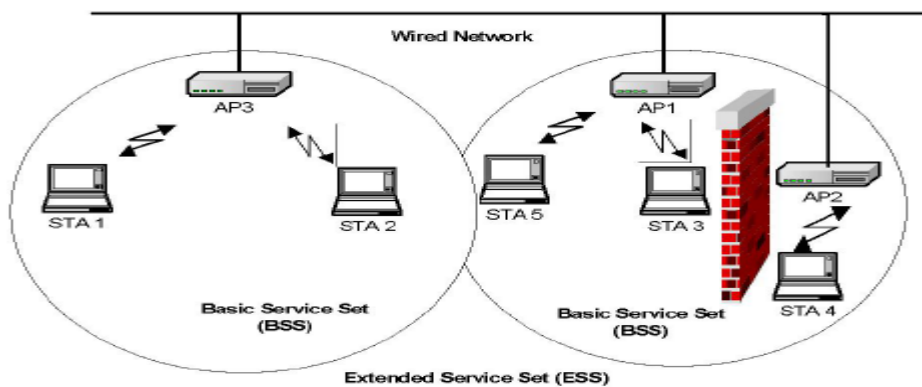

Figure 1.3: Architecture of a BSS with two access points

## 1.5 Roaming In IEEE 802.11

The IEEE 802.11 has to accommodate security and QoS support. The security issue in WLAN was solved using IEEE 802.11i amendment which introduces robust authentication, data integrity and encryption mechanisms. Also, IEEE 802.11e standard aims to provide QoS support to real-time applications. Such support can be performed by providing each STA with four access categories. However, this increases the management frames exchanged between the STAs and APs, especially during transition process. As each STA performs roaming from one AP to next, it should perform several steps as illustrated in figure 1.4. When the WLAN user accesses different APs then handoff latency may occur which causes packet loss and serious problems in real-time applications such as VOIP, video streaming etc. WLAN client decides to roam when connection strength of present AP begins to degrade. After that, clients scan new AP, re-associate, and re-authenticate to new AP. A roaming AP Group consists of a set of access points that are configured with the similar SSID and security settings. When a client roams, it connects to those of APs which have the same SSIDs.

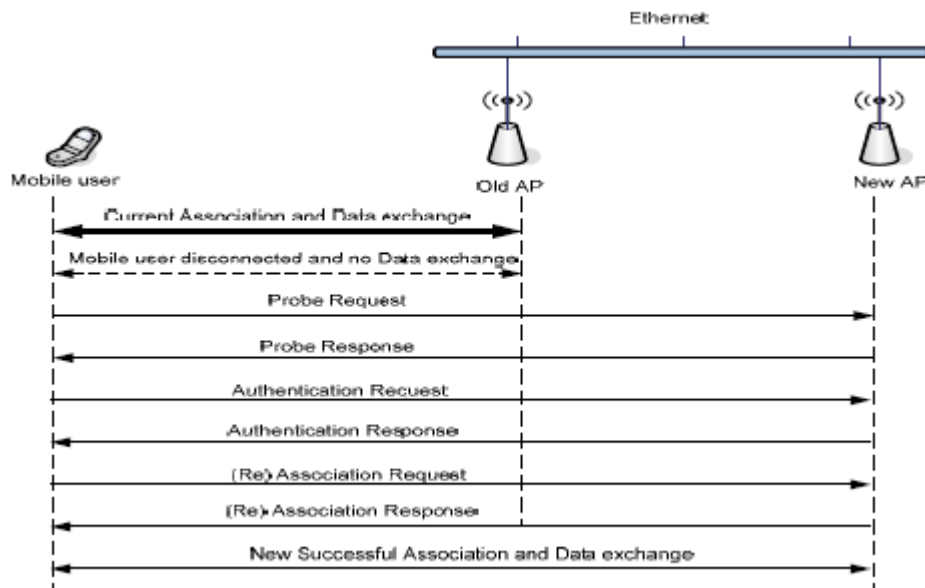

Figure 1.4: Roaming process in IEEE 802.11

**There are two types of WLAN roaming:[ 8 ]**

1. L2 Roaming (Internal Roaming)
2. L3 Roaming (External Roaming)

L2 Roaming occurs when mobile station moves from one AP to other APs that part of the same IP subnet. This is due to weak signal strength of home AP.

L3 Roaming occurs when the mobile station moves from one AP to other APs which are the part of different subnet. It is done when a client moves into another WLAN of another internet service provider and want to access their services.

## **1.6 Location And Handover Management In WLAN**

**Location Management:** When a station is associated to an AP BSS or ESS, the DS knows the position of the station in the basic service area or extended service area. As long as the station remains in basic service area (BSS) extended service area (ESS), the station is capable of transmit and receive frames to an AP [9].

**Handover management:** 802.11 manage the handover in terms of transitions. There are 3 different types of transitions:

1. **No transition**
2. **BSS transition**
3. **ESS transition.**

**No transition :** as the station remains in the AP service area, it makes no transition.

**BSS transition :** if a station was originally located in the basic service area of an AP1 and associated with this AP1,leaves this basic service area to enter the basic service area of AP2 of the ESS. The station then uses the service re-association for associating with the AP2, which then starts to send frames to the station. Requests a communication protocol between APs through the protocol IAPP. Indeed, during the re-association, AP2 must notify AP1 that the station is now associated with it. In this type of transition, the basic service area of the APs must overlap in part to ensure the mobility of stations.

**ESS transition :** an ESS transition corresponds to the movement of a station in an ESS1 to a separate ESS2. 802.11 supports this type of transition in the sense that the

station can associate with an AP of ESS2 leaving the extended service area of ESS1 but no guarantee is made to maintain the connection. In practice, the connection is supposed to cut. This means that the connections between network layer and upper layer are broken. To keep the network layer connections, the use of mobility protocols is required.

## 1.7 Types Of Handoff

Handoff can be classified into two types [10], i.e., Horizontal Handoff(Symmetric), which means the handoff is within the same wireless access network technology and Vertical Handoff(Asymmetric) which means that handoff among heterogeneous wireless access network technology.

### 1.7.1 Horizontal Versus Vertical Handoffs

A horizontal handoff is a handoff between base stations that are using the same kind of wireless network interface. This is the most common definition of handoff. Where a vertical handoff, as occurring between base stations that are using different wireless network interfaces. This naming convention follows from the overlay network structure, with networks with increasing cell sizes at higher levels in the hierarchy (figure 1.5).

Vertical handoffs are divided into two categories: an upward vertical handoff which is a handoff to a network with a larger cell size, and a downward vertical handoff which is a handoff to a network with a smaller cell size. These two cases are not necessarily symmetric: the handoff from a lower overlay (one with higher bandwidth per unit volume) to a higher overlay (one with lower bandwidth per unit volume) usually does not appear the same to a Mobile Host (MH), in terms of connectivity, as a handoff from a higher to lower overlay.

**There are some important differences between horizontal and vertical handoffs**

**These are:**

1. Many network interfaces have an inherent diversity that arises because they operate at different frequencies. For example, the room-size overlay may use

infrared frequencies, the building-size overlay network may use radio frequencies, and the wide-area data system may use yet different radio frequencies. Another way in which diversity exists is in the spread spectrum techniques of different devices. Some devices may use Direct Sequence Spread Spectrum, (DSSS), while others may use Frequency Hopping Spread Spectrum (FHSS).

2. In a single-overlay network, a MH is ideally within range of a single base station at a time. The MH is usually within range of multiple base stations only during a handoff. In a multiple-overlay network, a mobile device can be within range of several base stations simultaneously for long periods of time.
3. In a single-overlay network, the choice of “best” base station is usually obvious: the mobile chooses the base station with the largest signal strength, perhaps incorporating some amount of thresholding and hysteresis. In a multiple-overlay network, the choice of the “best” network cannot usually be determined by factors such as signal strength, because the networks have such varying characteristics. For example, an in-building RF network with a low signal strength may still yield better performance than a wide-area data network with a high signal strength.

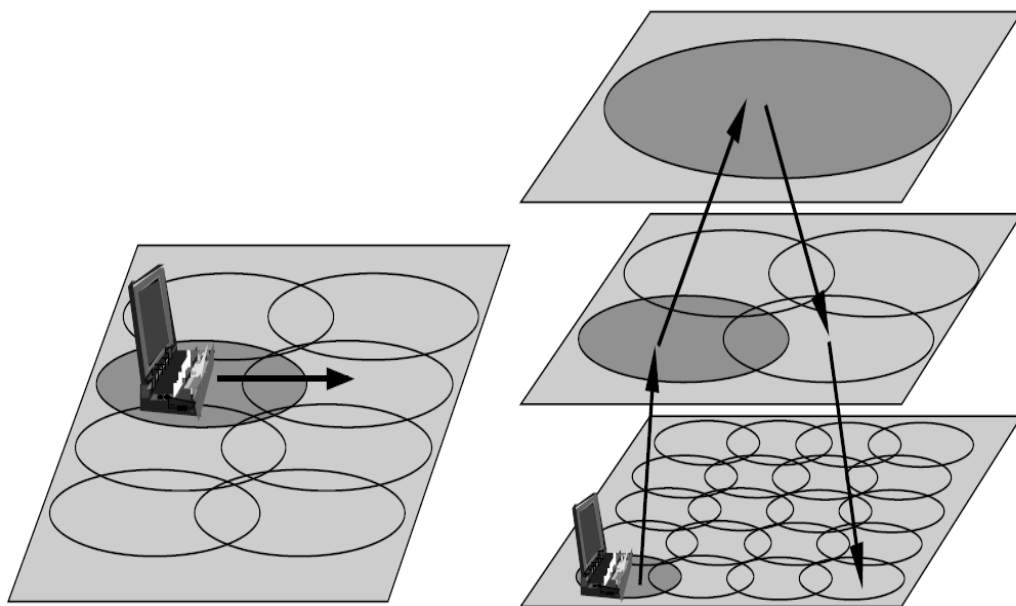

**Figure 1.5: (a) Horizontal handoff vs. (b) Vertical handoff**

### 1.7.2 Low Latency Handoff Schemes

The Low Latency Handoff Scheme in Mobile IP was found to reduce the period of time when a User Equipment (UE) cannot send or receive packets during Mobile IP registration process. It can be classified into two ways, pre-registration and post-registration. In the pre-registration scheme, a layer-3 handoff can be allowed to be in parallel with a layer-2 handoff. In the post-registration scheme, a layer-3 handoff registration begins after a layer-2 handoff ends.

Total handoff latency is a summation of detection time ( $t_d$ ), configuration time ( $t_c$ ), and registration time ( $t_r$ ).

Detection time is the period from UE's being within a new wireless access network to the moment that it obtains a router advertisement from the new access router. Configuration time is the period from the time that UE gets a router advertisement to the time that it assigns its interface with a new Care-of-Address "CoA" address. Registration time is the interval from the time UE sends a binding update to the time that it receives the first packet from the correspondent node. Registration time is the largest factor that contributes to handoff latency [11].

### 1.7.3 802.11 Handoff Process

Access points (APs) provide wireless connectivity by bridging packets from the wireless domain to an internal network. Due to mobility, a device may move and lose the signal from its AP. In that case, the mobile user should change to a new AP in order to maintain its wireless connectivity.

Figure 1.6 shows the main elements involved in a layer 2 handoff: the station (STA), the old AP, the new AP, and the distribution system (DS). It can be observed that basic service sets (BSS1 and BSS2) must belong to the same extended service set (ESS1). In the same way, radio channels of each cell (CHX, CHY) shall be none mutually interfering channels. The operation to change an association from one AP to another is known as a handover. Original design of the IEEE 802.11 standard [12] just considered the handoff signaling in the wireless part. The handover procedure can be divided into three phases: discovery, re-authentication and re-association[13].



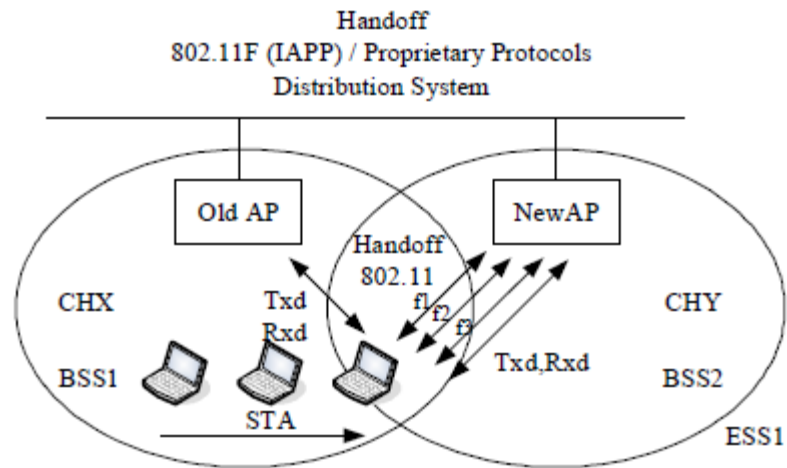
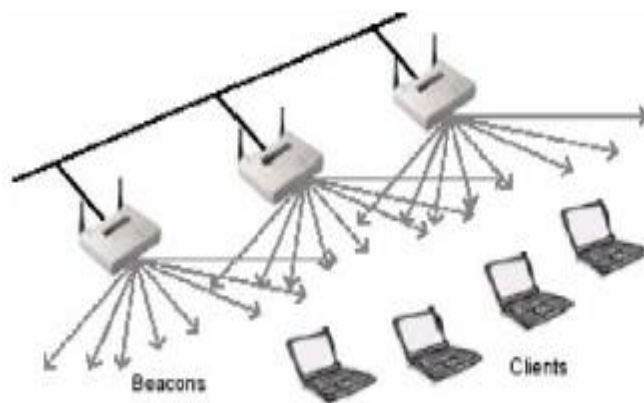

**Figure 1.6: Involved elements in layer 2 handover**

### 1.7.3.1 Handover Procedure

- **Phase 1: Discovery " Scanning "**

The discovery process can be either passive or active. Passive scanning consists of waiting for a beacon message, which is a frame periodically sent by APs as shown in figure 1.7. Usually, the beacon transmission period is configured at 100 ms , which makes the APs discovery in the scale of a second since there are 11 channels defined in the IEEE 802.11 standard, and the MN must scan channels one by one.

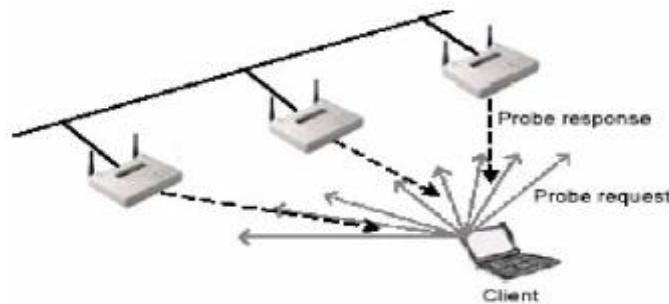

**Figure 1.7: Passive scanning of the discovery process**

Active scanning mode is shown in figure 1.8 , in order to determine whether an AP is operating on a particular channel, a MN periodically sends Probe Request messages. When an AP receives a Probe Request, it replies with Probe Response message. By this method, a MN pro-actively discovers the presence of APs. The duration of the scanning stage strongly depends on the number of channels which a MN has to probe.

In active discovery, the number of channels selected for Channel List defines two kinds of scans. The full-scan that sweeps all usable channels and the short-scan that sweeps only a subset of the channel spectrum.

In the discovery phase , the total delay is divided into two delays; CS-T (Channel Switch and Transmission ) and probe wait delay as shown in the figure 1.9. CS-T is the time to switch and transmit the probe request frame on channel .Probe wait delay is the time to spend on channel to gather all the probe responses from Aps operating on the channel[14]



**Figure 1.8: Active scanning of the discovery process**

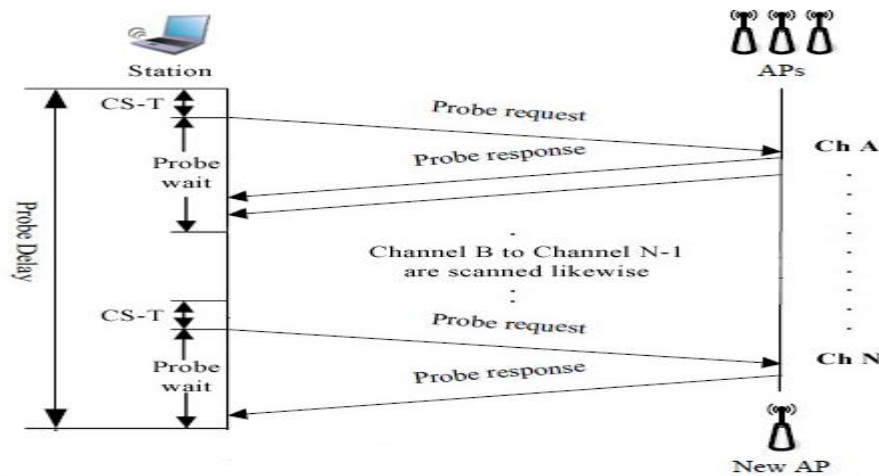

**Figure 1.9: Total delay in active scanning of the discovery process**

- **Phase 2: Re-authentication**

In this phase, the STA authenticates with the best discovered AP in phase 1. Authentication is a necessary prerequisite to association. However, IEEE 802.11 standard neither requires that authentication must immediately proceed to association nor the authentication must immediately follow a channel scan cycle. For this reason, some vendors have implemented pre-authentication schemes, e.g., discovery with pre-authentication and IAPP based pre-authentication. In the first scheme, the STA authenticates with the new AP immediately after the scan cycle finishes, getting anticipate the moment of re-association. The second scheme is accomplished even with greater anticipation; it is performed as soon as the STA associates with the first AP in the ESS. In that moment, IAPP sends through the distribution system, authentication information to all APs in the ESS, thus, when re-association is required, the STA is already authenticated with any AP. IAPP based pre-authentication is achieved even before STA enters to the discovery state, thus, it does not contribute to handoff latency.

- **Phase 3: Re-association**

Re-association is the process for transferring associations from one AP to another. Once the STA authenticates with the new AP, the re-association can be started. According to [15], re-association process is a six step process as shown in figure 1.10.

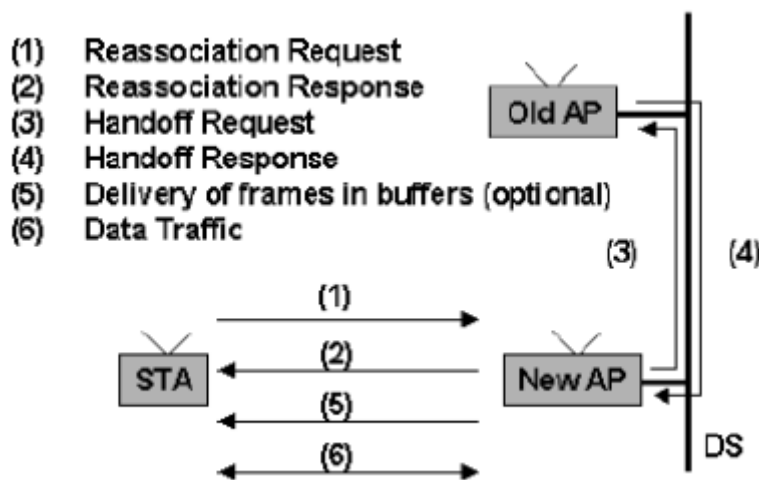

**Figure 1.10: Steps in the re-association process**

Figure 1.11, summarizes the handover procedure [16]. The overall delay is the summation of scanning delay, re-authentication delay and re-association delay. According to [15], 90% of handoff delay comes from scanning delay. To reduce scanning delay means to improve the handoff efficiency. The range of scanning delay can be represented by (3).

$$N \times T_{min} \leq T_{scan} \leq N \times T_{max} \quad (3)$$

where N is the total number of channels which is used in a country, T<sub>min</sub> is MinChannelTime, T<sub>max</sub> is MaxChannelTime and T<sub>scan</sub> is the total measured scanning delay.

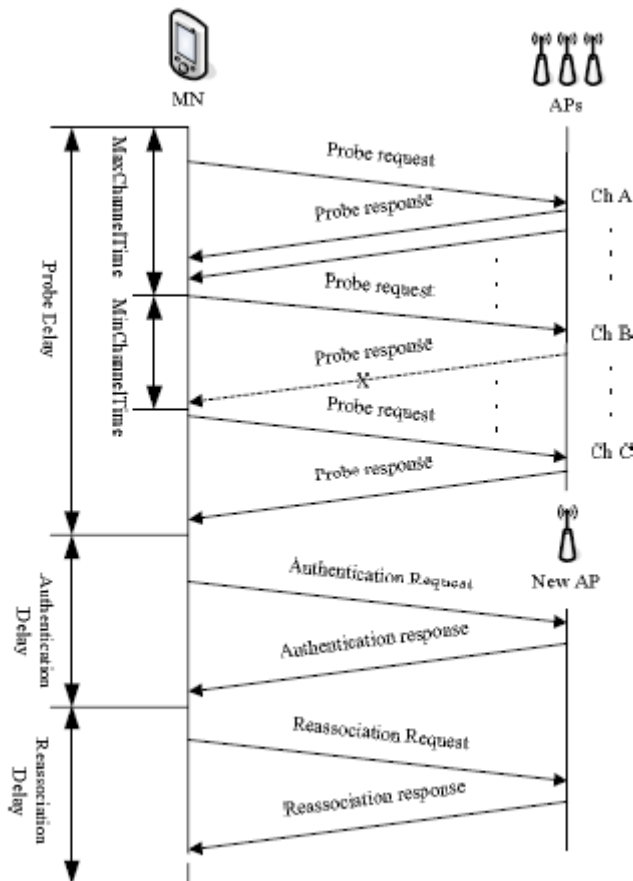

Figure 1.11: IEEE 802.11 Handover Procedure

#### 1.7.4 Handover Management

According to handover management the characteristics that make a big difference amid straight handover and straight down handover as follows:

- **Horizontal Handoff** : Handoff within the same access networks; actually it referred to as the intra-handover.
- **Horizontal Mobility**: The principle concern of horizontal handover is to maintain ongoing service by changing the IP address due to the mobility of MN. Maintaining ongoing session is done by hiding the change of IP address or dynamically updated the IP address. To hide the IP address changing during the movement of MN,

#### 1.8 Fast Handoff

In Fast Handoff, the handoff latency is further reduced by "hiding" the address configuration process (the process by the mobile node to acquire the new care-of address) from handoff [17]; the mobile node configures a new care-of address before handoff while data transfer continues during the address configuration.

Fast Handoff also reduces packet loss during the handoff process by [18] using an "IP tunnel" between the access router in the original network (PAR) and that in the new network (NAR), and [19] buffering packets at NAR. When the mobile node changes its connectivity to the NAR, packets reaching PAR are not dropped, but instead forwarded and buffered at NAR. The mobile node, once attaches to the new network, will notify NAR to deliver the buffered packets to it.

### 1.8.1 Fast-handoff Mechanism

The basic operation of the Fast-handoff [20] is illustrated in figure 1.12. Fast-handoff introduces seven additional message types for use between access routers and the MN. An access router is the last router between the wired network and the wireless network where the MN is situated. These seven messages are: Router Solicitation for Proxy (RtSolPr), Proxy Router Advertisement (PrRtAdv), Handover Initiation (HI), Handover Acknowledgement (HAck), Fast Binding Acknowledgement (F-BAck), Fast Binding Update (F-BU) and Fast Neighbor Advertisement (F-NA). In addition, the old Access Router (oAR) is defined as the router to which the MN is currently attached, and the new Access Router (nAR) as the router to which the MN is about to move to. A fast-handoff is initiated on an indication from a wireless link-layer (L2) trigger. The L2 trigger indicates that the MN will soon be handed off. Upon receiving an indication, the fast handoff scheme anticipates the MN's movement and performs packet forwarding to the nAR(s) accordingly. This is achieved by the MN sending a RtSolPr message to the oAR indicating that it wishes to perform a fast-handoff to a new attachment point. The RtSolPr contains the link-layer address of the new attachment point, which is determined from the nAR's beacon messages. In response, oAR will send the MN a PrRtAdv message indicating whether the new point of attachment is unknown, known or known but connected through the same access router. Further, it may specify the network prefix that the MN should use to form the new CoA. Based on the response, the MN forms a new address described using the stateless address configuration described in [21]. Subsequently, the MN sends a F-BU to the oAR as the last message before the handover is executed. The MN receives a F-BAck either via the oAR or the nAR indicating a successful binding. As the exact handoff instance is unpredictable, the oAR sends a duplicated F-BAck to the nAR to ensure the receiving of F-BAck by the MN. Finally, when the MN moves into the nAR's domain, it sends the Fast Neighbor Advertisement (F-NA) to initiate the flow of packets at the nAR. In addition to the message exchange with the MN, the oAR exchanges information with the nAR to facilitate the forwarding of packets between them and to reduce the latency perceived by the MN during the handoff. This is realized by the oAR sending a HI message to the nAR. The HI message contains

MN's requesting CoA and the MN's current CoA used at the oAR. In response, the oAR receives a Hack message from the nAR either accepting or rejecting the requested new CoA. If the new CoA is accepted by the nAR, the oAR sets up a temporary tunnel to the new CoA. Otherwise, the oAR tunnels packets destined for the MN to the nAR, which will take care of forwarding packets to the MN temporarily.

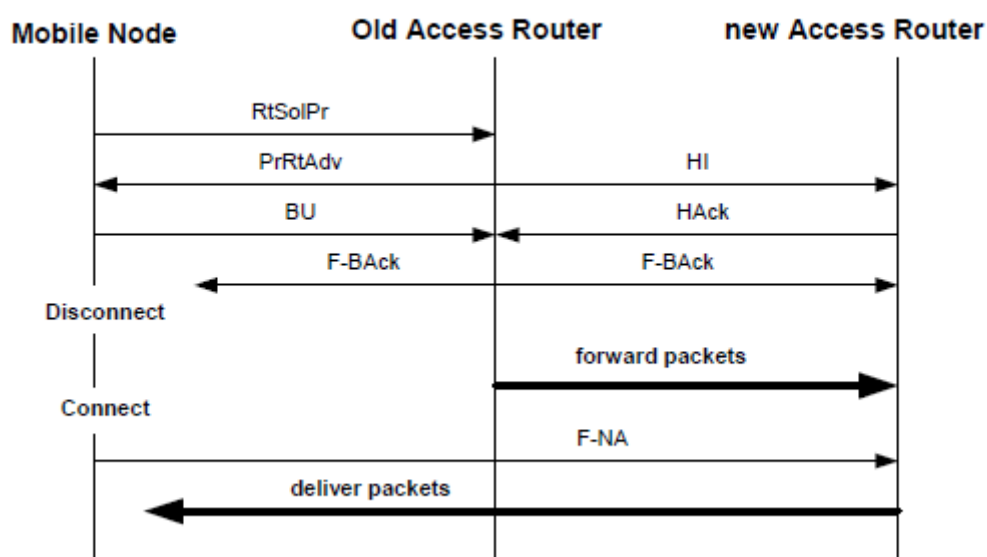

Figure 1.12: Fast handoff message interaction

# Chapter Two

## Related work



## 2.1 Introduction to related work

In this chapter we present a group of previous studies that discuss the handoff latency and their implemented algorithms which is used to find solutions to minimize 802.11 handoff latency. In table 2.1 we made some classification to the previous algorithm which did enhancement solutions for handoff delay .

Classification	Behavior
<b>Discovery Method</b>	<ul style="list-style-type: none"> <li>- <b>A novel discovery method</b> : Focuses on reducing both the total number of channels to be probed and the waiting time on each channel</li> <li>- <b>Discovery phase</b> : taking over 90% of the total handoff delay</li> <li>- <b>Selective scanning</b> : Selected subset of all available channels is probed . By using this channel mask, an MH can reduce the amount of unnecessary time that it spends probing on existent channels among neighboring Aps</li> <li>- <b>SyncScan</b> : The MH regularly switches to each channel and records the signal strengths of the channels. By doing so, the MH can keep track of information on all neighbor APs.</li> <li>- <b>MultiScan</b>: Requires an additional radio interface for the channel scanning. In MultiScan, the primary interface is associated with the current AP. At the same time, the secondary interface is performing the channel scanning..</li> </ul>
<b>Adaptive Method</b>	<ul style="list-style-type: none"> <li>- <b>AdaptiveScan</b> : It is intended to reduce overhead caused by prescan. After scanning all channels, the MN divides channels into three groups based on RSS</li> </ul>
<b>Fast Handoff</b>	<ul style="list-style-type: none"> <li>- <b>Fast handoff scheme</b> : Avoiding probe wait (FHAP).It takes advantage of inter-AP communications. After an MN sends a probe request message, it then switches to the next channel immediately without waiting for response messages.</li> <li>- <b>A fast and practical handover solution</b> : It is a software module residing in 802.11 drivers, which explores RSNI-based proactive scan and issues advanced resource request to the target AP</li> </ul>

Table 2.1: Some of related work , handoff algorithms classification and its behavior

<p><b>Predictive Handoff</b></p>	<ul style="list-style-type: none"> <li>- <b>A predictive handoff scheme</b> : In this scheme, an MH's authentication information is proactively distributed to multiple APs depending on the MH's mobility pattern and service class</li> <li>- <b>A soft proactive handover</b> : predicts the time that a handover process is going to start using the RSSI values and receives the lightweight base layer code of the SVC-encoded video during a certain interval before the predicted handover starts</li> </ul>
<p><b>Neighbor Caching</b></p>	<ul style="list-style-type: none"> <li>- <b>Proactive neighbor caching</b> : Transfer the context ahead of mobile node in a proactive manner. To determine the potential next AP, it uses the neighbor graph which dynamically captures the topological information of the wireless network</li> <li>- <b>Selective neighbor caching</b> : Propagate the MN context to the neighbor AP's whose handoff probabilities are equal to or higher than a predefined threshold value</li> </ul>

**Table 2.1: Continue: some of related work , handoff algorithms classification and its behavior**

## 2.2 Classification Method Of Related Work

### 2.2.1 Discovery Method

In [14] , it is shown how the discovery phase (scanning time) is the most time consuming part of the handoff process, taking over 90% of the total handoff delay, while (re)association time contributes only a few milliseconds.

In [22] Velayos et al. proposed a scanning mechanism using topographical knowledge of access point placement. If each client is made aware of its neighboring access points and their channels, the client can then probe a reduced set of channels during the scanning phase and spend less time on each channel. While this approach is attractive, the maintenance and dissemination of this knowledge potentially represents a large management burden for those deploying large-scale 802.11

networks , They found that scanning delay can be reduced by 20%, when using active scanning with its timers MinChannelTime and MaxChannelTime set to 1 and 10.24 ms.

In [23], present a novel discovery method using a neighbor graph (NG) and a nonoverlap graph (NOG). This scheme (referred to as the NG-pruning scheme focuses on reducing both the total number of channels to be probed and the waiting time on each channel. They suggested two algorithms: the NG and NG-pruning algorithms. The rationale behind these algorithms is to ascertain whether or not a channel needs to be probed (by the NG algorithm) and whether the MH has to wait more probe response messages on a specific channel before the expiration of MaxChannelTime (by the NG-pruning algorithm). Using the NG, the set of channels on which neighboring APs are currently operating and the set of neighbor APs on each channel can be learned. Based on this information, an MH can determine whether or not a channel needs to be probed. On the other hand, the NOG abstracts the nonoverlapping relation among the APs. Two APs are considered to be nonoverlapping if and only if the MH cannot communicate with both of them simultaneously with acceptable link quality.

In [24], a selective scanning algorithm with a caching mechanism was proposed (referred to as the channel mask scheme). In the channel mask scheme, only a well selected subset of all available channels is probed. Channel selection is performed by means of a channel mask that is built when the driver is first loaded at the MH. Specifically, full-scan is triggered at first and the channel mask is then constructed by the information obtained in the first full-scan. In IEEE 802.11b, only three channels do not overlap among all 11 channels. Hence, in a well-configured wireless network, all or most of the Aps operate on channels 1, 6, and 11. Consequently, the channel mask is formed by combining three frequent channels (i.e., 1, 6, and 11) and the channels scanned at the first full-scan. By using this channel mask, an MH can reduce the amount of unnecessary time that it spends probing on existent channels among neighboring APs. To further reduce the handoff delay, a cache mechanism was also introduced. The basic idea of the caching

mechanism is for each MH to store its handoff history. When an MH associates with an AP, the AP is inserted into the cache maintained at the MH. When a handoff is needed, the MH first checks whether there is an entry corresponding to the current AP's MAC address in the cache. If there is a matched cache entry, the MH can associate with the AP without any further probing procedures.

In [25], the authors proposed an improved scanning mechanism to minimize the disconnected time while the wireless station (STA) changes the associated access points (APs). The STA has to scan all channels in the scanning phase. They based on the neighbor graph (NG), and introduce a selective channel scanning method for fast handoff in which the STA scans only channels selected by the NG. They reported a reduction of probe delay to 30 ms by using NG.

In [26], a new handoff scheme, called SyncScan, was proposed to reduce the probe delay. Unlike the existing probe procedures defined in IEEE 802.11, SyncScan allows an MH to monitor the proximity of nearby APs continuously. In other words, the MH regularly switches to each channel and records the signal strengths of the channels. By doing so, the MH can keep track of information on all neighbor APs. Moreover, through continuous monitoring the signaling quality of multiple APs, a better handoff decision can be made and the authentication/reassociation delay can be also reduced. To minimize the packet loss during the periodical monitoring, the power saving mode (PSM) in the IEEE 802.11 specification is utilized. Since SyncScan is based on the regular monitoring of APs, time synchronization is a critical issue. For synchronization with APs, the network time protocol (NTP) can be leveraged. On the other hand, if multiple APs use the same channel and they generate beacons at the same time, a randomization technique can be employed.

In [27], Brik et al. introduced a handoff scheme utilizing multiple radios called MultiScan . Similar to Sync-Scan , MultiScan obtains information on neighbor APs by scanning opportunistically. However , MultiScan requires an additional radio interface for the channel scanning. In MultiScan, the primary interface is associated with the current AP and used for data transmission. At the same time, the secondary

interface is performing the channel scanning. If a handoff to a new AP is required, the second interface is associated with the new AP while the primary interface is still employed for data transmission. After the completion of a new association by the secondary interface, interface switch from the secondary interface to the primary one is triggered. As a result, the formerly secondary interface becomes primary for data transmission and the formerly primary interface is used for channel scanning. Consequently, MultiScan achieves a make-before-break handoff by using multiple radio interfaces.

In [28], it shows that the latency is usually over 300ms, which can result in service interruption in delay-sensitive applications, such as video applications, and also cause packet loss during the handover process, thereby degrading QoE. So it is necessary to decrease the handover latency in order to ensure the QoE of the multimedia application. This proposes a neighbor list proactive (NLP) based-handover scheme. IEEE 802.11 standard probes all the eleven channels to search a target AP based on received signal strength indicator (RSSI). Probing one channel involves sending and receiving of probing packets over that channel and takes about 15ms. The channel switching delay is about 10ms. Therefore the total delay of channel probing procedure is 265ms. The actual handover action exchanges a pair of authentication packets and a pair of association packets between the AP and the terminal, which takes less than 20ms. It can be seen that channel probing time plays an important role in the handover process. If the channel probing time can be reduced, it will reduce the handover time delay effectively. So far the most popular channel probing strategy is active probing, in which the terminal actively sends a probe request and waits a period of time on the channel to receive all probe responses. Each channel needs to execute this probing once at a time until probing of all the channels is finished. By performing this scan into background before actual handover, the delay can be made satisfactorily low for most applications. However, the long background active scan will heavily interfere with normal traffic [29].

In [30], each station is equipped with dual interfaces. The first interface is used for normal data communication and the second one is used for the channel

scanning. In this way, channel scanning process does not interfere with normal data communication.

### **2.2.2 Adaptive Method**

In [16], called Adaptive Preemptive Fast Handoff (APFH). It imposes that the STA must predetermine a new AP before the start of handoff . When the handoff threshold is reached, the STA jumps the discovery phase and starts directly the reauthentication phase. This process reduces the overall handoff latency.

In [31], AdaptiveScan adopts a similar pre-scan technique, but it is intended to reduce overhead caused by pre-scan. After scanning all channels, the MN divides channels into three groups based on RSS. Channels with lower RSS are scanned less frequently. However, once the RSS of a channel exceeds the weaker RSS of a channel in the group of higher RSS channels, this channel will be moved to that group and will replace the weakest.

### **2.2.3 Fast Method**

In [32], A fast handoff scheme by avoiding probe wait (FHAP) is a fast handoff scheme that takes advantage of inter-AP communications. After an MN sends a probe request message, it then switches to the next channel immediately without waiting for response messages. The AP that has received the probe request sends a response to the previous AP using the inter-access point protocol or a protocol of a vendor. The previous AP is the AP that the MN is associated with before this handoff. The MN is then connected with the previous AP again and gathers the probe responses through it.

In[33], the author proposed a fast and practical handover solution with QoS guarantee in IEEE 802.11 wireless LANs. It is a software module residing in 802.11 drivers, which explores RSNI-based proactive scan and handoff triggers and issues advanced resource request to the target AP. Implementation on typical 802.11 test bed demonstrate that, comparing to existing 802.11 drivers.

#### 2.2.4 Predictive Method

In [34], Pack et al. proposed a predictive handoff scheme for reducing the authentication/re-association delay (referred to as the FHR scheme). In this scheme, an MH's authentication information is proactively distributed to multiple APs depending on the MH's mobility pattern and service class. To predict the MH's mobility pattern, a concept of frequent handoff region (FHR) was introduced. The FHR is a set of APs which have high possibilities of being visited by an MH in the near future. The FHR is constructed based on the handoff frequency and the MH's priority at the centralized system.

In [35], the author proposed a soft proactive handover scheme that exploits the received signal strength indicator (RSSI) and scalable video coding (SVC). The proposed scheme predicts the time that a handover process is going to start using the RSSI values and receives the lightweight base layer code of the SVC-encoded video during a certain interval before the predicted handover starts. It shows that the proposed scheme can minimize service interruption times during the 802.11 handover operations, thereby increasing QoE quality of experience.

#### 2.2.5 Neighboring Method

In [36], proactive neighbor caching scheme was proposed to reduce the context transfer latency. PNC scheme transfer the context ahead of mobile node in a proactive manner. To determine the potential next AP, it uses the neighbor graph which dynamically captures the topological information of the wireless network. When neighbor AP is determined it transfer the mobile node context to it in advance. Currently PNC scheme is included in the Inter access point protocol (IAPP) specification.

In [37], Sangheon Pack proposed selective neighbor caching (SNC) which is quite similar to PNC. An AP in SNC scheme, proactively propagate the MN context to the neighbor AP's whose handoff probabilities are equal to or higher than a predefined threshold value. The optimal performance of SNC scheme depends on the value of threshold, which has to be carefully determined.

### 2.2.6 Triggering Method

In [38], Gandhi describes handoff procedures in WLANs and discusses the tolerance to access point failures. Gandhi goes into detail on the exact process used to handoff from one access point to another and how this process works when an access point fails on the WLAN. He discusses how to determine when an access point fails and different techniques to tolerate failure such as the Overlapping-Coverage Approach.

In [39], project where tens of access points with roof mounted antennas formed a mesh around campus. Roofnet's emphasis is more on route maintainability and optimization than on handing off a client's connection.

In [40], designs a flat routing protocol which is triggered by an MN's reassociation to decrease the overall handoff latency.

In [41], Mohanty et.al. presented a cross layer mobility model where the data link layer and the network layer could be used for speed and handoff signaling delay estimation. It was called Cross Layer Handoff Management Protocol.

In [42], Dutta et.al. shows an efficient mechanism for GPS assisted handoffs in real time communication systems. It provides a new methodology that can provide faster IP address discovery using GPS coordinates of the mobile station.

In [43], proposes a context-based network selection algorithm and the corresponding communication algorithms between WLAN and CDMA networks. It focuses on a handoff triggering criterion which uses a network selection method which uses context information such as the dropping probability, blocking probability.

In [44], the author proposed fuzzy logic based handoff algorithm. In this algorithm they consider the parameter like bandwidth, RSS, BER, time delay. This algorithm is basically designed to reduce call dropping.



In [45], the author uses Multiple Attribute Decision Making Method (MADM) for both getting the value and combining the network parameters.

For schemes proposed in [46] and [48], both the link layer and the network layer are involved in the mobility management process to reduce the handoff latency.

In [47], Nundy et.al. discusses how to reduce false handoff initiation in low latency networks, using speed and signal strength information, which in turn will help reduce handoff delay and resultant overhead.

In [49], a control channel is introduced for direct communications between MNs and mesh routers in wireless mesh networks. This will accelerate the handoff process between the MNs and APs. A handoff process may likely involve mobility management in the network layer. With mobility management, those that have ongoing communications with an MN will still be able to reach the MN after a handoff.

In [50], the author proposed scheme, in which they were consider two additional parameters along with RSS , Network status Information, Mobile Movement Prediction And energy level of mobile node, during handoff process.

In [51], the author created new layer between data link layer and network layer. This newly added layer is going to decide the physical interference which is used to send and received the data during handoff process.

In [52], the author proposed a handoff algorithm based on dynamic weight compensation. This algorithm ensures the accuracy of network selectivity by adjusting the parameters of decision matrix.

In [53], the author proposed two vertical handoff decision algorithms for a mobile node either staying in the UMTS or WLAN/WiMAX networks are proposed.

Initially, the PRSS(predictive RSS) conditions are different for real time and non-real time services. Dwell time depending on the mobile node movement is used as a counter to check the continuity of the PRSS conditions to be true long enough .After triggering a handoff, the target network is selected among candidates by the largest merit value. The proposed vertical handoff and network selection reduces packet delay and increases the throughput of WLAN/WiMAX networks.

In [54], the propose of a methodology focuses on achieving reduced overall handoff latency by implementing handoff delay duration less than 150ms which is the need for seamless service in IEEE 802.11 WLAN. Their algorithm uses Multiple –Interface Seamless handoff where each AP has multiple WNIC (Wireless Network Interface cards) working in different channels

# Chapter Three

## Proposed Approach

### 3.1 Introduction

In this chapter, we propose a solution for reducing handoff latency that occurs when a mobile moves from one access point to another.

A mobile has many parameters, some of these parameters affect the delay result when a mobile moves from access point A to access point B. we study these parameters and control them to get low handoff latency. Packets Reception Power Threshold is a one parameter that paly a main role in reducing handoff delay.

#### 3.1.1 Packets Reception Power Threshold

[ 55 ] Defines the received power threshold (receiver sensitivity) value of the radio receiver in dBm for arriving WLAN packets. Packets with a power less than the threshold are not sensed and decoded by the receiver. Hence, such packets don't change the receiver's status to busy and they are not detected by the WLAN MAC through its physical sensing mechanism. The status of such packets are set to noise; and so they cause interference and possibly bit errors if they collide with valid packets at the receiver.

The packets whose received power is higher than threshold are considered as valid packets. They are sensed by the MAC and they can be received successfully unless they get bit errors due to interference, background noise and/or colliding with other valid packets.

Unless the default transmission power is considerably lowered, all the WLAN packets should reach at their destinations with sufficient power to be a valid packet, when the propagation distance between the source and destination is less than 300 meters as required by the IEEE 802.11 WLAN standard.

The value of the "high threshold trigger" between the radio receiver and the MAC module in the surrounding node model will be overwritten by the value of this attribute in Watts.

### 3.1.2 Tools Used

We used the OPNET 14.5 (Optimized Network Engineering Tool) simulator for our proposed solution which is graphical user interface .

The simulation tool we are using OPNET which is running under windows 7 environment. This tool is a set of decision support tools, providing a comprehensive development environment for specification, simulation and performance analysis of communication networks, computer systems and applications. It allows us to create models in great, execute simulations, and analyze the output data.

OPNET provides four hierarchical editors to develop a modeled system, Network Editor, Node Editor, Process Editor, and Parameter Editor. The basic building block is a node, which is an underlying model. Nodes are corresponding to communication devices such as PC, file server, printer, and router.

We start building the wireless networking model with creating a project with Model Family “wireless\_lan”. A subnet is created to represent the office wireless network. Within the subnet, we put various numbers access point (AP) as a wireless router to transmit wireless signals, and various numbers of workstations according to different scenarios. The AP is connected to a bridge router and then connected to a server which provides applications used for the workstations. We also need to define applications and profiles by adding a node for each, and we can associate the work station with the profiles in order to use the applications.

## 3.2 Proposed Fast Handoff Solution

In this schema, the client (Mobile) gets information about the nearby access points which can be calculated by the techniques like GPS. Then the client determining the connectivity between a client and access point by calculated different packets reception power threshold value for handoff .The Received Signal Power should be strong enough between a client and access point to maintain proper signal quality at the receiver and when a client moves away from the current access point becomes weaker .A client connected with the current access point by

predefined packets reception power threshold and moves by default ground speed (GS) (meter/second), when a client goes away from the current access point and the received signal power is less than packets reception power threshold, at this moment it is necessary to using a proposed solution for fast handoff decision and maintain data from dropped.

### 3.2.1 Steps For Proposed Fast Handoff Decision

- 1- Localize the nearby access points to the client by GPS
- 2- When the client is connected to the entire network with access point and is attempting handoff with current access point. Then handoff will occur only when the Received Signal Strength (RSS) is less than packets reception power threshold( TH).
- 3- When the handoff occurs and the client disconnected from the current access point, the client enters scanning about new  $RSS > TH$ .
- 4- The Client selected the next nearest access point.
- 5- For fast scanning and connecting with suitable RSS, decrease TH by 1 as  $TH = TH - 1$  and increase GS by 1 as  $GS = GS + 1$ .
- 6- Continue repeated the step 5 for  $RSS > TH$  then connected with it.
- 7-  $TH = \text{Predefined TH}$  and  $GS = \text{Default GS}$ .

Figure 3.1, shows the flow chart of a proposed algorithm Fast Handoff Decision. As we note from figure 3.1, the mobile select the next access point from mapping table access points, this step mean that the mobile no enter in the probe phase which take 90% from handoff delay as in previous studies.

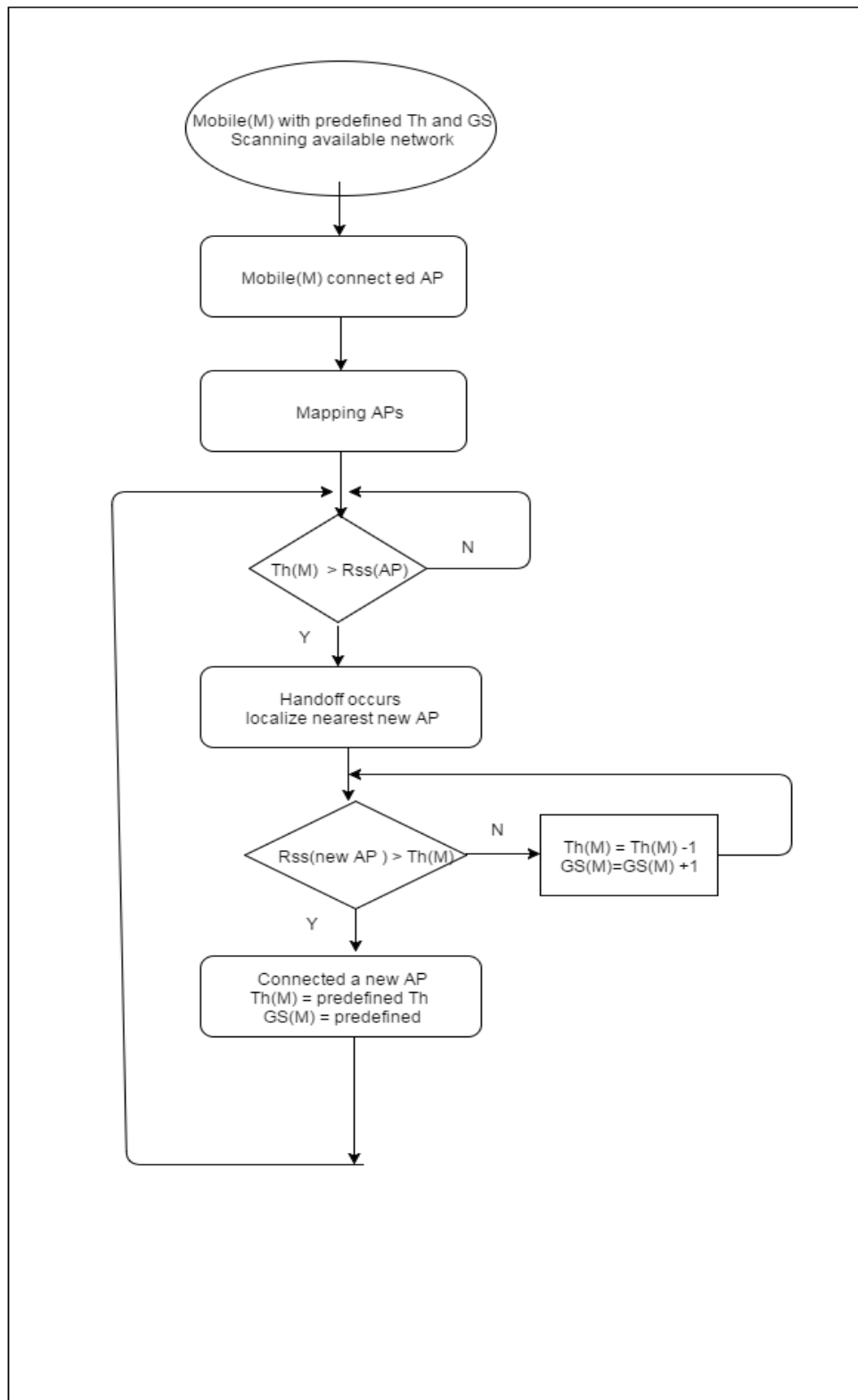

**Figure 3.1: Flow chart for our proposed algorithm Fast Handoff Decision**

### 3.2.2 Location by GPS

Most of the mobiles nowadays are provided with GPS. GPS becomes an important application and has a great demand especially among the users mobile. GPS allows users to access a world map which is very vital to guide and suggest the best directions while users are moving around. With the assumption that all mobiles are provided with this function, we propose localize the nearby access points to the mobile using GPS application. By activating the GPS application the mobile will become actually knowledge of its current location and neighbors access points then can simply determine distance and direction between a mobile and an access point. Through this property the mobile can determine the received signal power from all access points and can selected the nearest access point with best received signal power signal.

Figure 3. shows a real snapshot which we take in IUG-University campus by using Wi-Fi-analyzer android application. The figure 3. shows different access points and its received signal power signal, which reduce scanning delay.

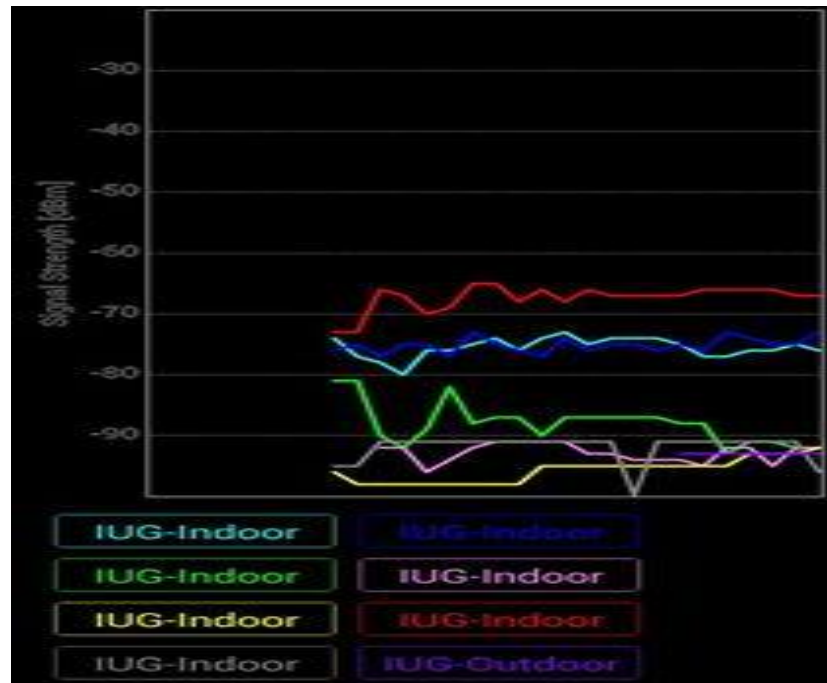

Figure 3.2: Snapshot of access point signal strength in IUG-University campus



### 3.2.3 Triggering With Packets Reception Power Threshold

A mobile may leave or enter into specific access point coverage and the next access point selection is triggering Packets Reception Power Threshold. The evaluation of mobile location changes is based on the RSS. Generally, a handoff trigger is decided by the RSS of access point which is less the Packets Reception Power Threshold of mobile. In our approach, decreasing the RSS and increasing mobile speed are criteria for handoff triggering and access point selection which reduce handoff delay .

We assume the following variables to determine the horizontal handoff:

- TH: predefined threshold value.
- GS : ground speed of mobile.

As the mobile moves away from the coverage of the access point and the signal strength falls. Mobile identify the next access point through known the nearest access point, the mobile Packets Reception Power Threshold is decreased and compared with RSS until the RSS of selected access point is strong enough then connected with new access point.

### 3.2.4 Mapping Table

The mobile retrieves indices of the candidate next access point from the access point table which stores at most two target access points to scan with respect to locations of access points. These indices are used to retrieve MAC addresses and channel frequencies from a Mapping Table, which stores MAC addresses and channel frequencies for all the access points. The mobile selects the access point with the strongest RSS. After that, this value is compared to Packets Reception Power Threshold. For example, if the threshold is -85 dBm, the mobile only connects to an AP whose RSS is greater than -85 dBm. So our approach depend on decreasing Packets Reception Power Threshold to reduce the handoff time to become RSS is greater than Packets Reception Power Threshold. Finally, the mobile performs authentication and re-association to complete the handoff process.

# **Chapter Four**

## **Simulation**

### **And Results**

This chapter discusses implementations of handoff on OPNET simulator and the results we get.

#### 4.1 Important Attributes Changed for each Node

##### 1- Access Point :

The WLAN access point node model (Figure 4.1) is a wireless LAN based router with an Ethernet interface. It is used as a router in wireless networks and it connects the wireless network to wired networks.

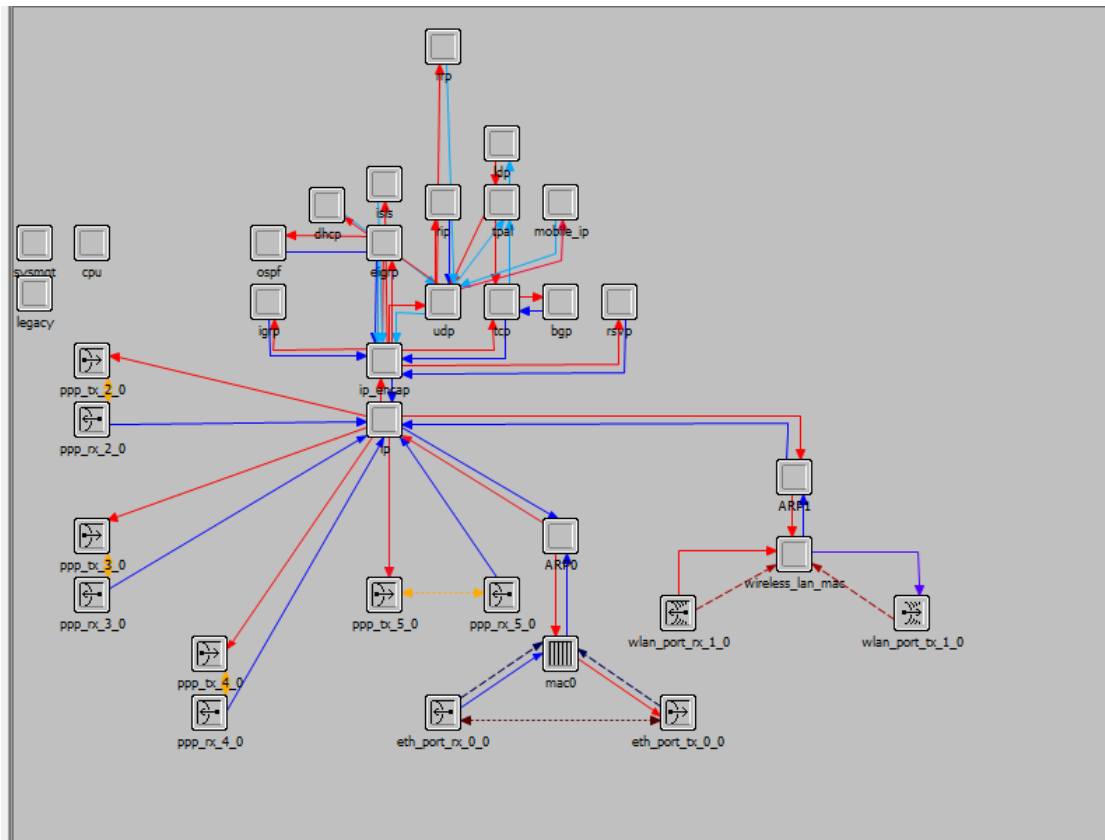

**Figure 4.1: WLAN access point node model**

The parameters which we configure the access point in our simulation are shown in the Table 4.1

<b>Node Model</b>	wlan_ethernet_slip4_adv
<b>BSS Identifier</b>	same level number as the associated Workstations
<b>Access Point Functionality</b>	Enabled
<b>Operation Mode</b>	802.11g
<b>Data Rate</b>	54Mbps
<b>Transmission Power</b>	0.005W

**Table 3.1: Parameters of WLAN access point node model**

**2- Workstation :**

The WLAN workstation node model (figure 4.2) is a workstation with client-server applications running over TCP/IP and UDP/IP.

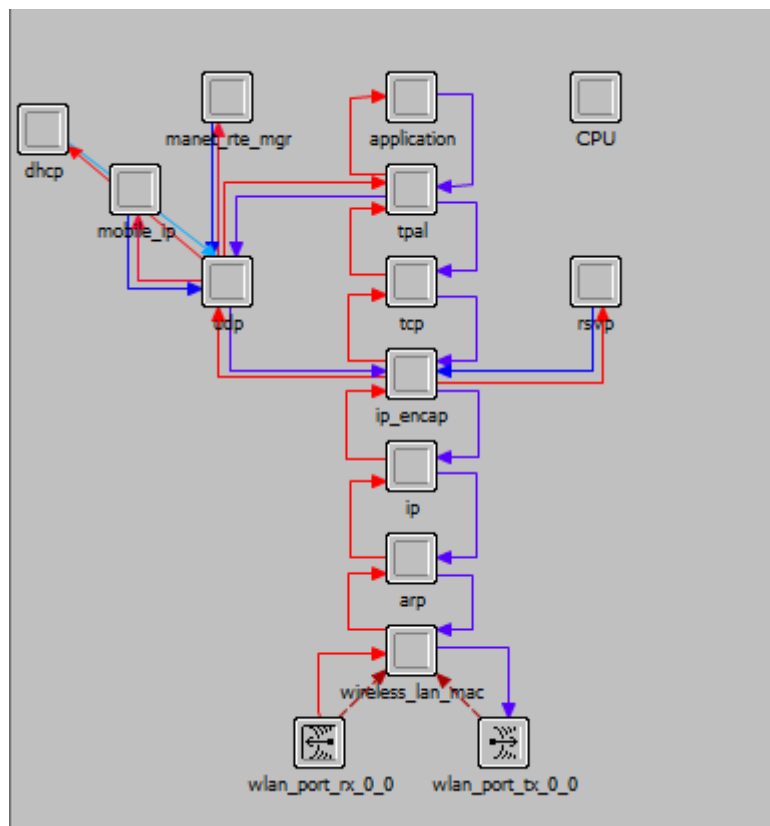

**Figure 4.2: WLAN workstation node model**

Table 4.2 shows the general parameters of mobile workstation configurations which are used in our scenario

<b>Node Model</b>	wlan_station_adv
<b>BSS Identifier</b>	same level number as the associated AP
<b>Supported Application</b>	varies corresponding to different scenarios
<b>Access Point Functionality</b>	Disabled
<b>Operation Mode</b>	802.11g
<b>Data Rate</b>	54Mbps
<b>Transmission Power</b>	0.005W
<b>roaming</b>	enable

**Table 4.2: Parameters of mobile workstation node model configurations**

### 3- WLAN station:

The WLAN station node model (Figure 4.3) is an IEEE 802.11 wireless LAN station. The node model consists of an ON/OFF (active/inactive) traffic source, a sink, a wireless LAN interface, and a receiver/transmitter pair.

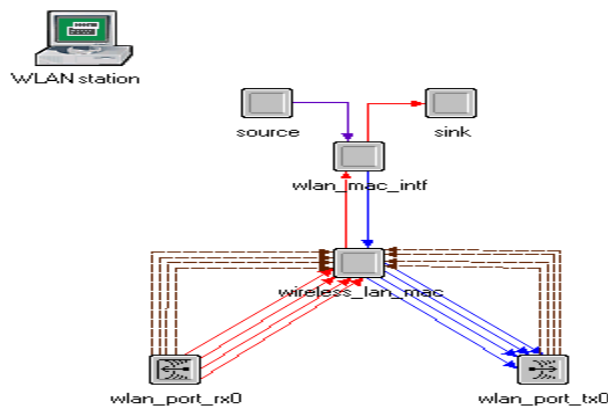

**Figure 4.3: The WLAN station node model**

## 4.2 Scenarios Configuration

We used three scenarios to simulate the performance of two different application types classified by the transport layer. VoIP scenario for UDP where UDP generates the datagram into the lower layer regardless of the packet loss in the lower layer, a number of the packet loss is generated by the handoff of the mobile. On the other hand, HTTP scenario for TCP where TCP does not send more data than the CWND (Congestion WiNDow). So in the case of TCP, few packet losses are generated by handoff of the MS.

In order to model an application in OPNET, an object is available which is called application definition attribute. Application definition attribute can be modified as the user requirements.

Figure 4.4, shows the Application Definition attribute used in simulation model. Two applications (HTTP and VoIP) are modeled in our simulation by using the Applications attributes.

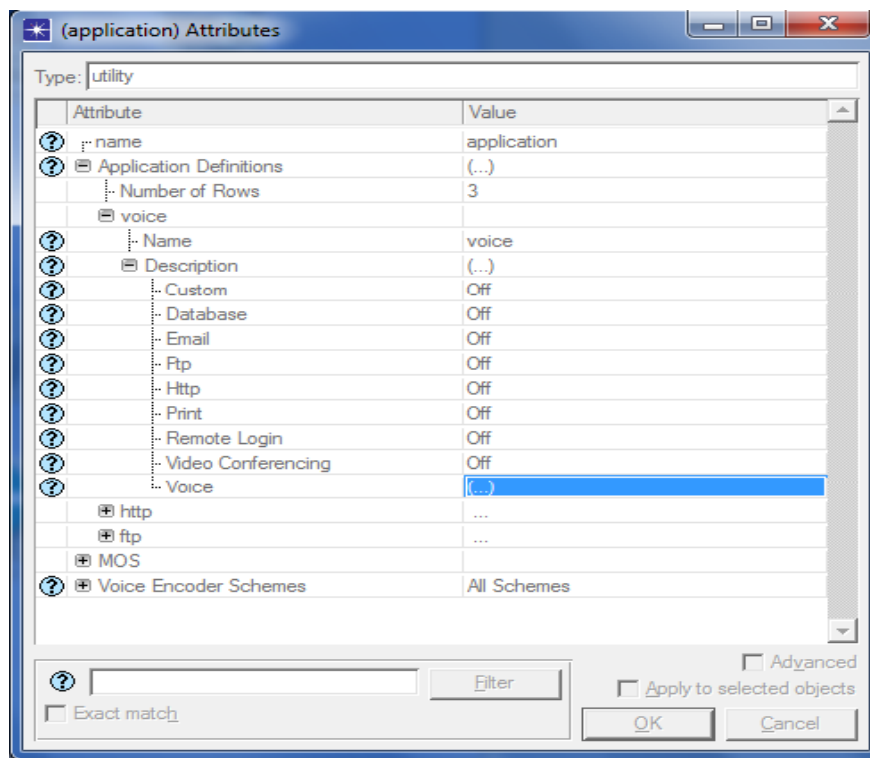

Figure 4.4: Application definition

### 4.2.1 VoIP Scenario

The VoIP over WLAN application is used to emulate real-time traffic as the application that uses UDP. The infrastructure mode was applied by arranging a number of workstations within APs, which form a wireless connection between all IEEE 802.11.

This scenario shows the mobile workstation is moving during horizontal handoff (roaming) between 3 APs. This scenario shows IEEE 802.11g wireless technology. The Mobile is roaming from AP1 to AP3 at the speed of 1 m/s. in a predefined trajectory .

The measurements of VoIP quality of service based on different parameters like delay, jitter, packet loss.

#### 4.2.1.1 Parameters of VoIP QoS

**Packet Delay Variation:** It represents the variance among end to end delays for voice packets and is measured from the time it is created to the time it is received.

**Mean Opinion Score (MOS):** is used to check which factor affecting the quality of voice and its value changes from 1 to 5, the lowest value show the lowest quality of voice and highest value show the best quality of voice.

**Traffic Received (packets/sec):** Average number of packets per second forwarded to all voice applications by the transport layer in the network.

**Packet End To End Delay:** It represents the time taken to send voice applications to a destination node application layer. This statistic records data from all the nodes in the network.

**Traffic Sent (packets/sec):** Average number of packets per second submitted to the transport layer by all voice applications.

#### 4.2.1.2 Simulation Parameters ( Table 4.3)

Parameter	Value
Access Points	3
workstation	2
Traffic Type	Voice

**Table 4.3: Simulation parameters used in VoIP scenario**

The Voice application is modeled by configuring the (*Voice*) *Table* which can be seen in Figure 4.6. The VoIP application uses G.723.1 5.3K encoder scheme and Interactive Voice (6) as the type of service for establishing the VoIP calls.

After configuring the VoIP application in Application Definition there is a necessity to define which work station will be using this VoIP application. In our scenario Mobile 1 and Mobile 2 are the workstations (shown in Figure 4.5) that will run the VoIP application. The behavior of the work station is described by its Profile which is defined by using the Profile Definition. Figure 4.7 shows the Profile Definition object used in our simulation which describes, the start time of the simulation is set at 3 seconds and the VoIP application is repeated continuously till the end of simulation. It means that VoIP calls are established between workstations Mobile 1 and Mobile 2 starting at 3 seconds and the calls are added continuously till the end of simulation.

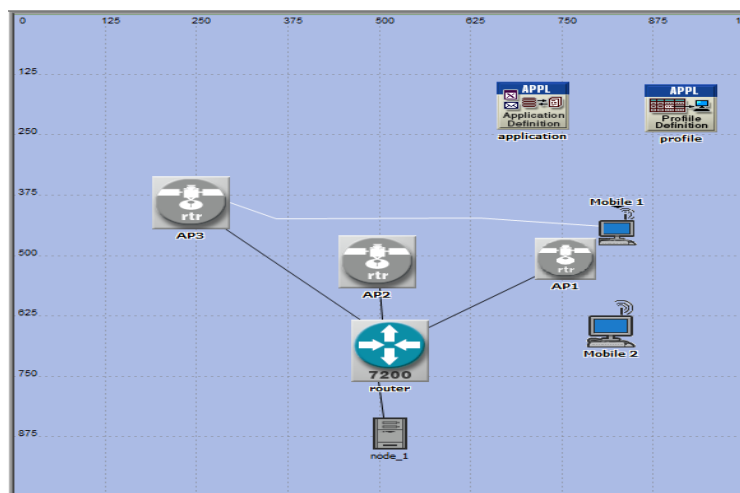

**Figure 4.5: VoIP scenario**



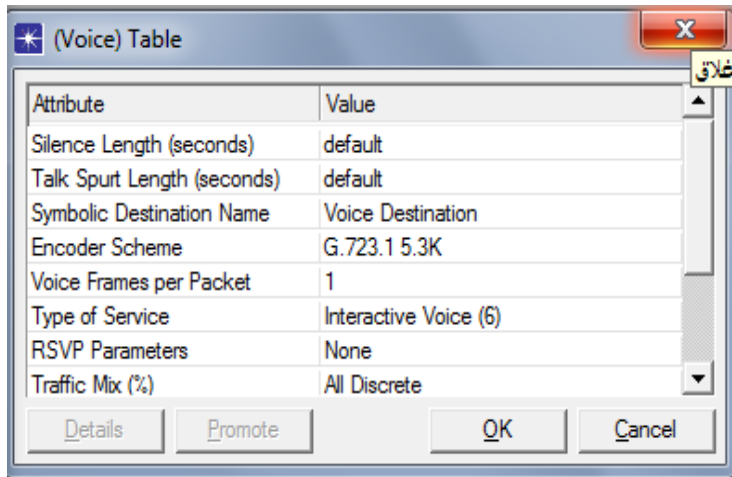

Figure 4.6: (Voice) Table

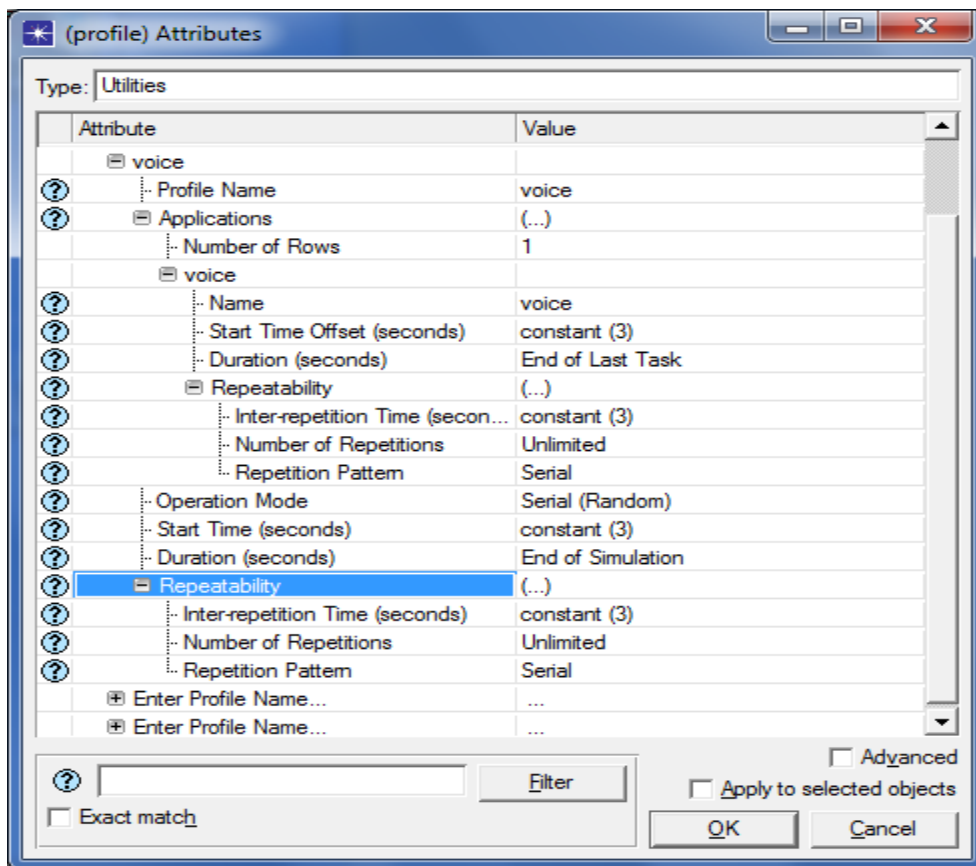

Figure 4.7: Profile definition (VoIP)

In OPNET, the task of calculating the minimum number of the calls that can be maintained in the given network is done by configuring the profile definition. The profile is configured in a way that each VoIP call is added after a fixed interval of time and the process of adding the call is repeated till the end of simulation.

The first VoIP call is established at the third second of the simulation then for every 3 seconds a VoIP call is added to the simulation. The addition of VoIP call is done by repeating the VoIP application for every 3 seconds in the profile definition. This process is repeated till the end of simulation. In this way the VoIP calls are added continuously at fixed interval.

In order to implement VoIP calls, we define conversation pairs between the source node Mobile 1 and the destination node Mobile 2. The conversation pairs can be defined in the traffic center.

#### **4.2.2 HTTP Scenario**

In this scenario, we use HTTP as the application that uses TCP and make Mobile to handoff while the Mobile is browsing images from HTTP server. Figure 4.8 shows the network configuration and the path that MS moves along.

In this HTTP Scenario as shown in the Figure 4.8 , a workstation Mobile runs the HTTP application and browses images and moves with roaming between 3 access points (AP1,AP2 and AP3) , and shows the network configuration and the path that MS moves along predefined trajectory.

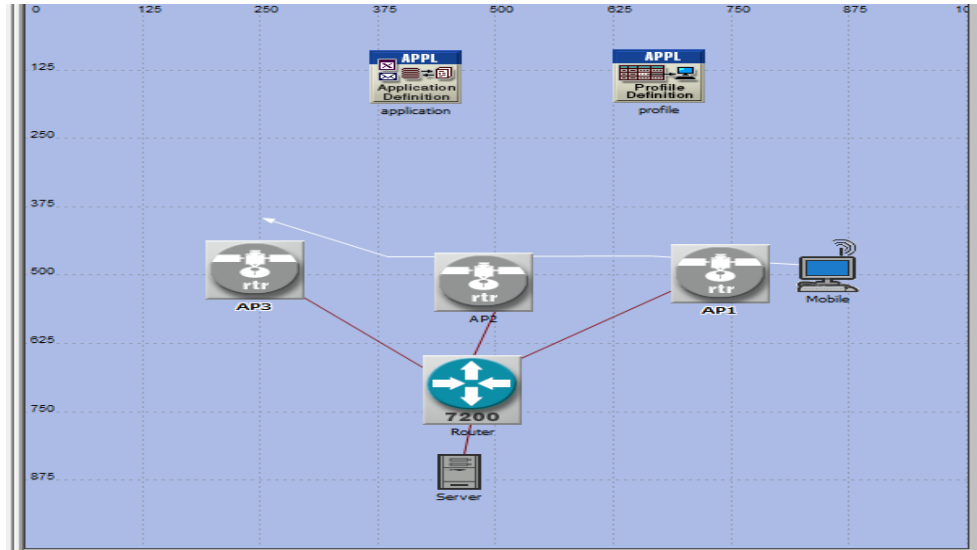

**Figure 4.8: HTTP scenario**

### 4.2.3 Case Study : Extended Scenario

Figure 4.9 shows a network simulation inside of a building which has four floors. There were four APs on each floor. We took configurations for access points from Islamic University–Gaza for one building and implemented it on an OPNET simulator to measure an average delay by applying our proposed approach .In each floor the Aps were connected to a switch and all switches in the floors were connected with a main switch which was connected with a router to form one subnet. In this scenario the mobile roams through a building and in each floor measures the delay resulted from handoff and at the end of measurements calculated average delay. As shown in figure 4.9 and 4.10 .Mobile 1 moves in floor-4 then floor-3 then floor-2 then floor 1.and roaming between 16 access point.

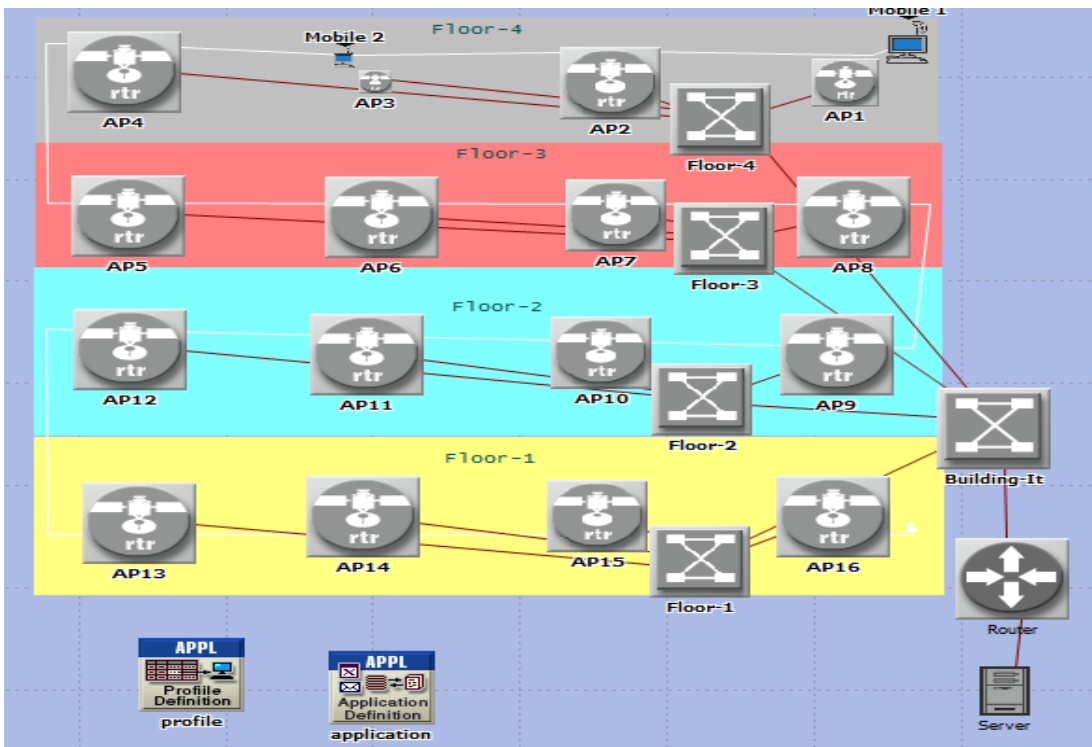

Figure 4.9: Extended scenario which contains 16 Aps on four floors

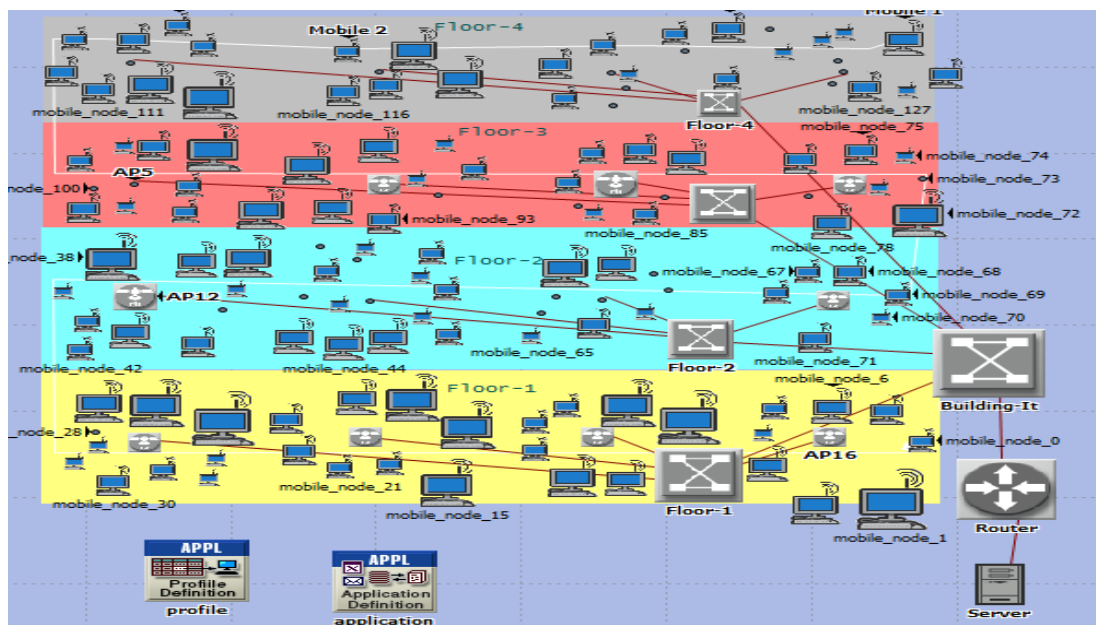

Figure 4.10: Extended scenario which contains 16 APs on four floors and 140 Mobile

## 4.3 Results And Discussions

This section discusses the behavior of handoff under two different scenarios. While the Mobile roams between access points affecting the results of the handoff time, delay and throughput in our experiment. We begin our study by testing the performance of the topology and observe the influences of moving Mobile node between Access Points. But before we begin to analyze the graphs, there is an important thing to know, namely how OPNET traces access points connectivity for the nodes stations in the different scenario we implement .

### 4.3.1 Scenario 1: VoIP Scenario Analysis

The purpose of this scenario is to analyze the handoff characteristic of VoIP calls in term of different parameters

There are some other metrics to measure QoS of VoIP scenario. We measure and analysis Jitter, End-to-End delay, Packet loss and MOS.

- **Connectivity**

When the MAC is disconnected from its current AP a value of "-1" is written into this statistic, and when it is connected to a new AP then the "BSS ID" of the new AP is recorded. The MAC is assumed to be unconnected while it is in scanning mode, during which it searches for an AP with a satisfactory connection quality. If this WLAN MAC belongs to an infrastructure BSS but roaming is not enabled for it or if the MAC itself is an AP, then the MAC will never enter into the scanning mode. Hence, the statistic will again contain a single value recorded at the beginning of the simulation, which will be the "BSS ID" of the MAC's BSS.

Figure 4.11 shows that the AP connectivity for the Mobile 1 in VoIP scenario before using our proposed approach, where AP1 BSS\_ID is 1 , AP2 BSS\_ID is 2 and AP3 BSS\_ID is 3.

We have seen at 95 sec , the Mobile 1 disconnected from AP1 and enters scan mode and the handoff occurs , and at 200 sec , the Mobile 1 disconnected from AP2 and enters scan mode and the handoff occurs.

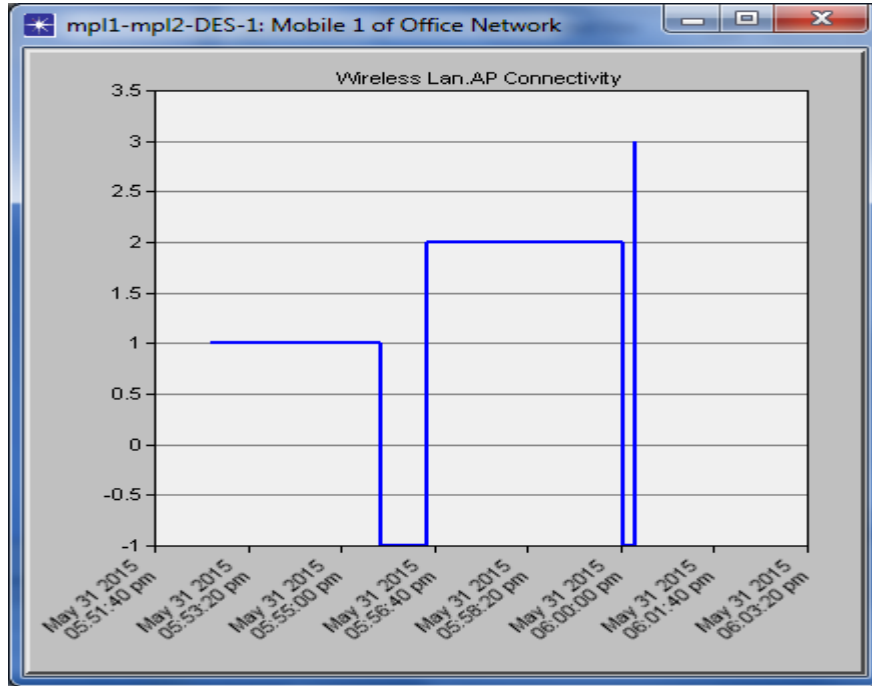

**Figure 4.11: Wireless LAN access points connectivity**

- **Wireless LAN Delay**

Figure 4.12 shows the Wireless LAN delay that when handoff occurs with constant packets reception power threshold  $-76$  dbm **and constant** ground speed  $1\text{m/s}$ . After we applied our proposed approach with initial packets reception power threshold  $-76$  dbm of Mobile 1 and ground speed  $1\text{m/s}$ . At the first time the Mobile 1 connected with AP1 and making a voice calling with Mobile 2 which connected to the AP1. When the received signal strength of AP1 to Mobile 1 is sufficiently weak (less than threshold), Mobile 1 selecting the nearest access point, decreasing packets reception power threshold until reconnected with new access point as shown in figure 4.13. Also we see by increasing the ground speed of Mobile at the moment of disconnection, contributes in decreasing the delay that result from handoff.

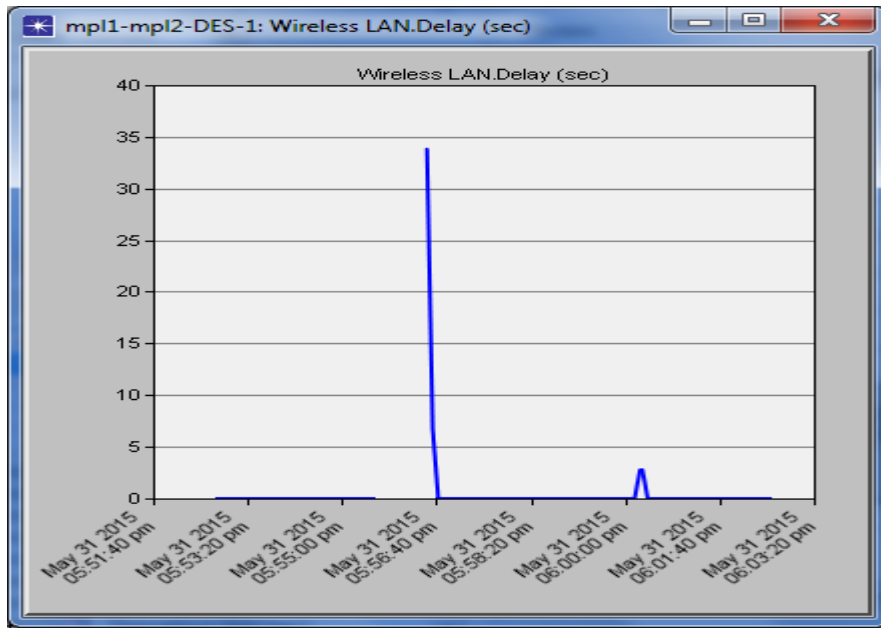

Figure 4.12: Wireless LAN delay in sec without proposed approach

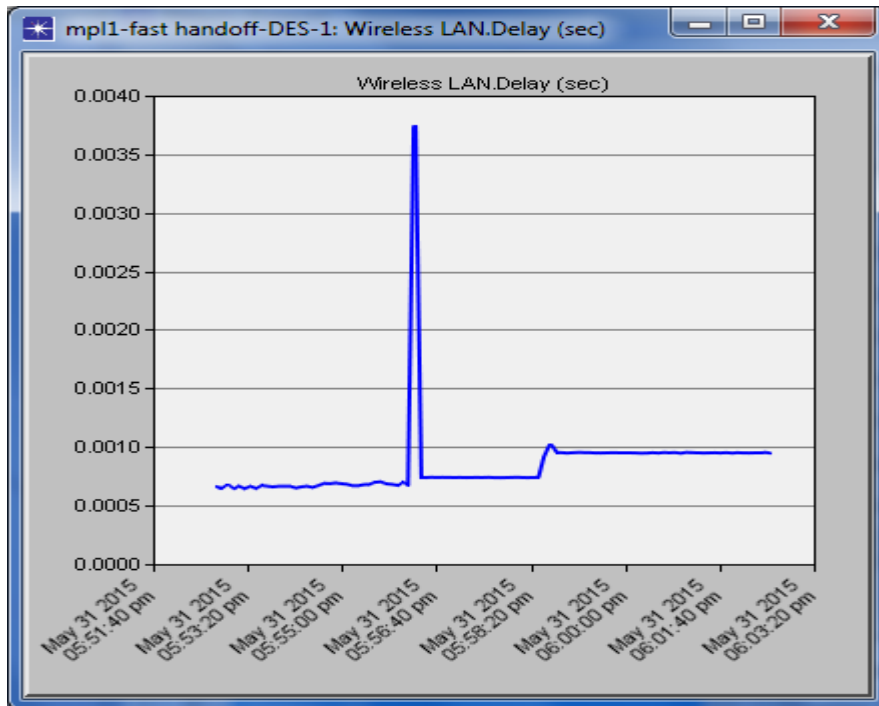

Figure 4.13: Wireless LAN delay in sec using proposed approach

Table 4.4 shows handoff delay with suitable packets reception power threshold and ground speed.

Handoff	Packets reception power threshold dbm	Ground speed m/s	Delay (Sec)
Handoff 1	-79	3	0.0037
Handoff 2	-78	2	0.0010

**Table 4.4: Different handoff for VoIP scenario**

- **Wireless LAN Throughput**

Figure 4.14 shows the throughput performance measured in bits/sec. Zero values that appeared at some specific time of the throughput, this is due to the handoff that occurs when Mobile is dealing with mobility. During these instances, the data packets would be dropped.

Figure 4.15 shows the throughput performance measured in bits/sec after using our proposed approach and how the zero values disappeared and no data packet drops.

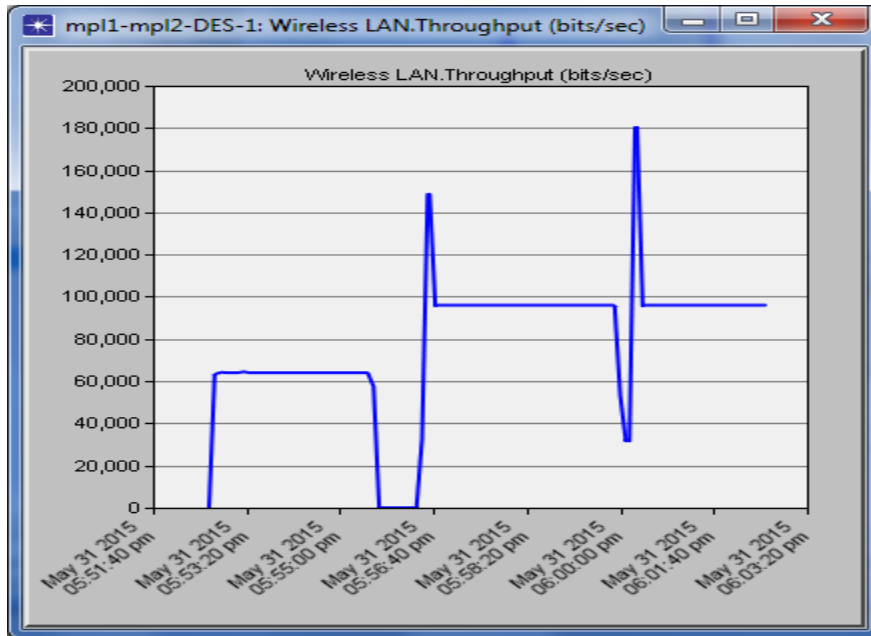

**Figure 4.14: Wireless LAN throughput (bits/sec) with big handoff**



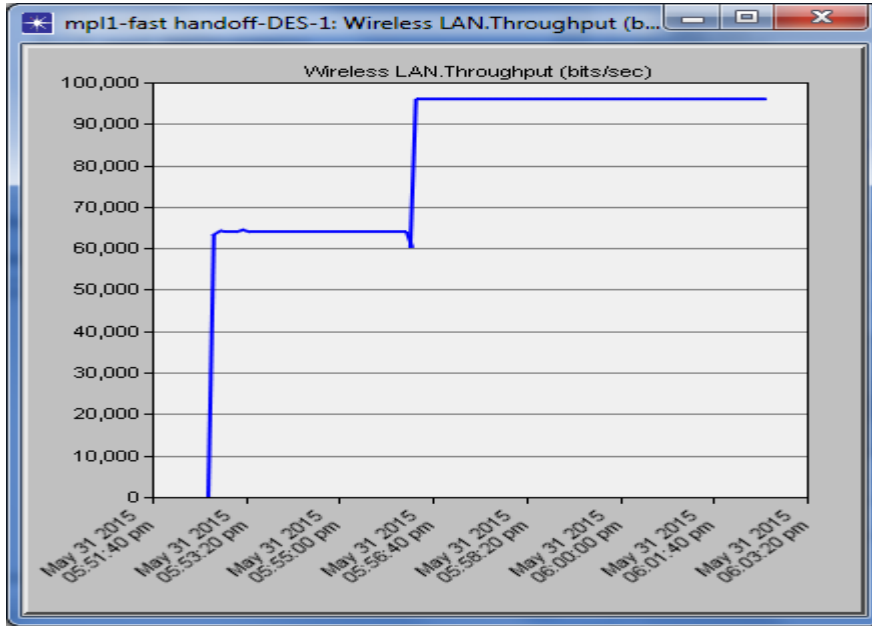

Figure 4.15: Wireless LAN throughput (bits/sec) with proposed approach

- The affected of handoff proposed approach on other VoIP Metrics

1- Jitter

Figure 4.16 shows comparison for Jitter values between normal handoff and a proposing fast handoff. In normal handoff, a big period for jitter delay than proposing fast handoff and we get low value and small period when using a proposed fast handoff.

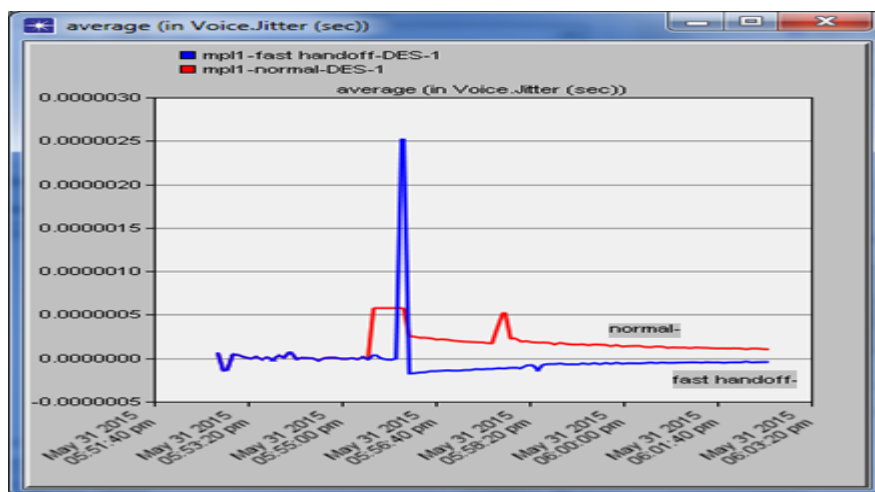

Figure 4.16: Average (in Voice Jitter ) sec

## 2- End to End Delay

Figure 4.17 shows comparison for End to End delay between normal handoff and a proposing fast handoff. We see high value of End to End delay reaches to 0.7 sec in case of normal handoff but low no delay increases in case of proposed fast handoff.

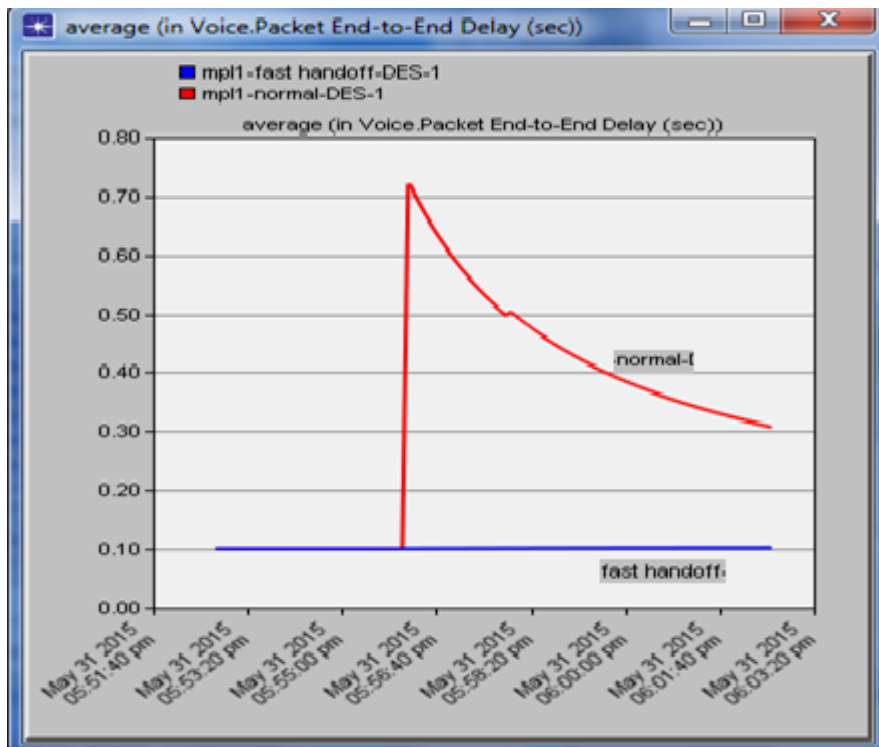

Figure 4.17: Average (in Voice Packet End to End delay) sec

## 3- Delay Variation

Figure 4.18 shows a variation in delay when normal handoff occurs and reaches to 13 but we don't see changing in delay when proposed fast handoff occurs where its values zero .

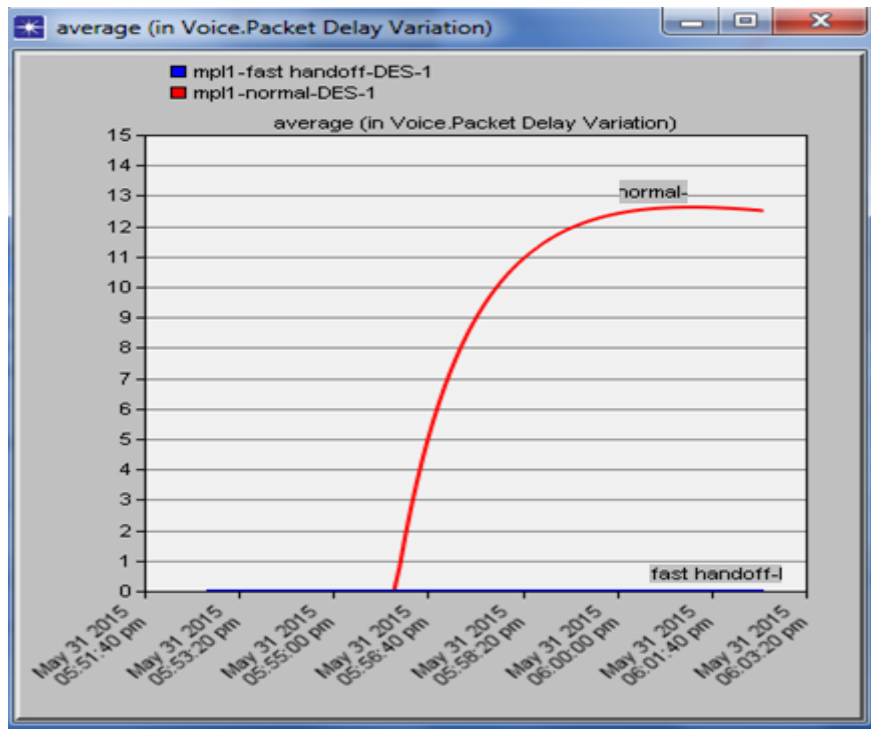

Figure 4.18: Average (in Voice Packet Delay Variation )

#### 4. Mean Opinion Score (MOS)

Figure 4.19 shows MOS best values 2.6 when proposed fast handoff occurs. But this value decreasing to less than 2 if normal handoff occurs .

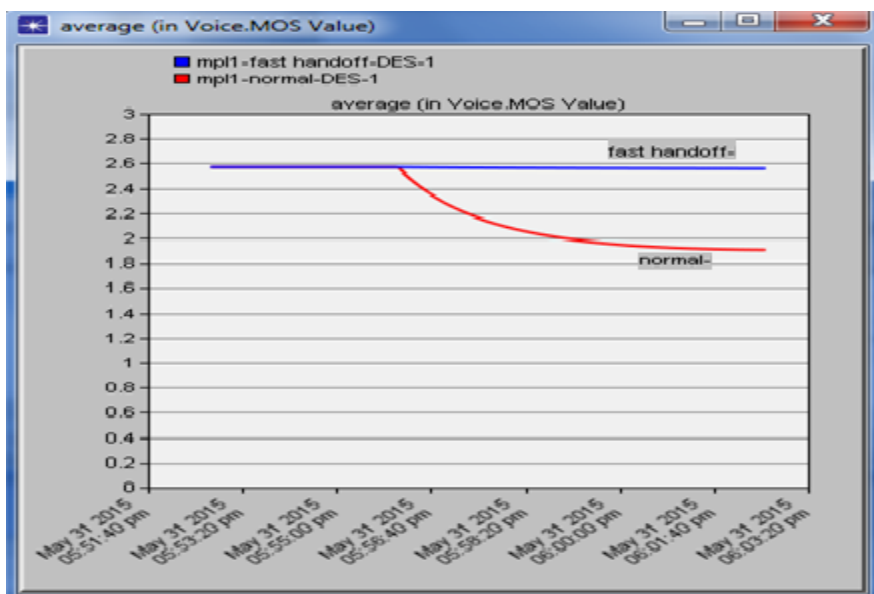
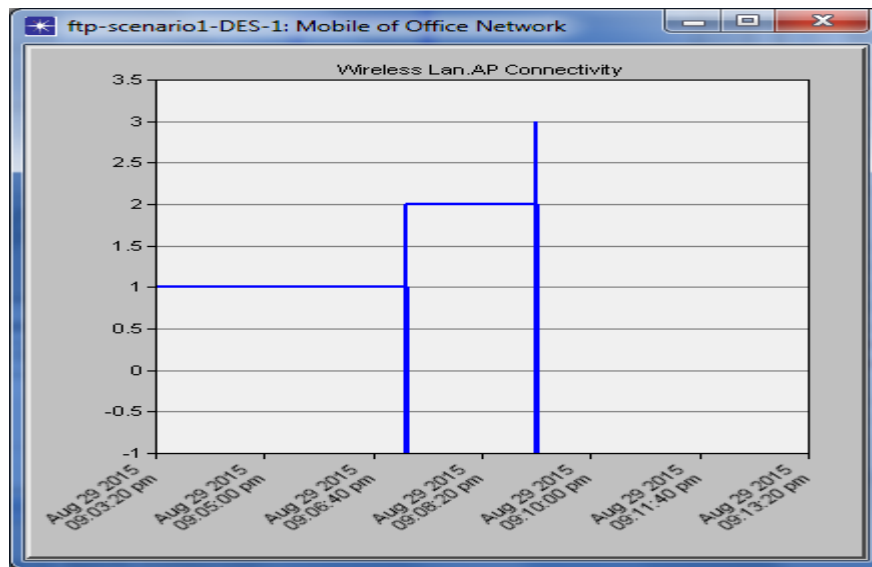

Figure 4.19: Average (in Voice MOS Value )

### 4.3.2 Scenario 2 : HTTP Scenario Analysis

In HTTP scenario ,we use our proposed approach for http application and we evaluate the handoff delay and throughput and be much better with using our proposed approach.

Figure 4.20 , shows the connectivity of Mobile when roaming between the three access points



**Figure 4.20: Wireless LAN Connectivity of Mobile in HTTP Scenario**

Figure 4.21 , shows the Wireless LAN Delay and at the time that the handoff occurs , no delay increased because the fast handoff reconnect with new access point

Figure 4.22 , shows the throughput bits/sec with no drops of data when handoff occurs and our proposed approach save the best level of transmitted data.

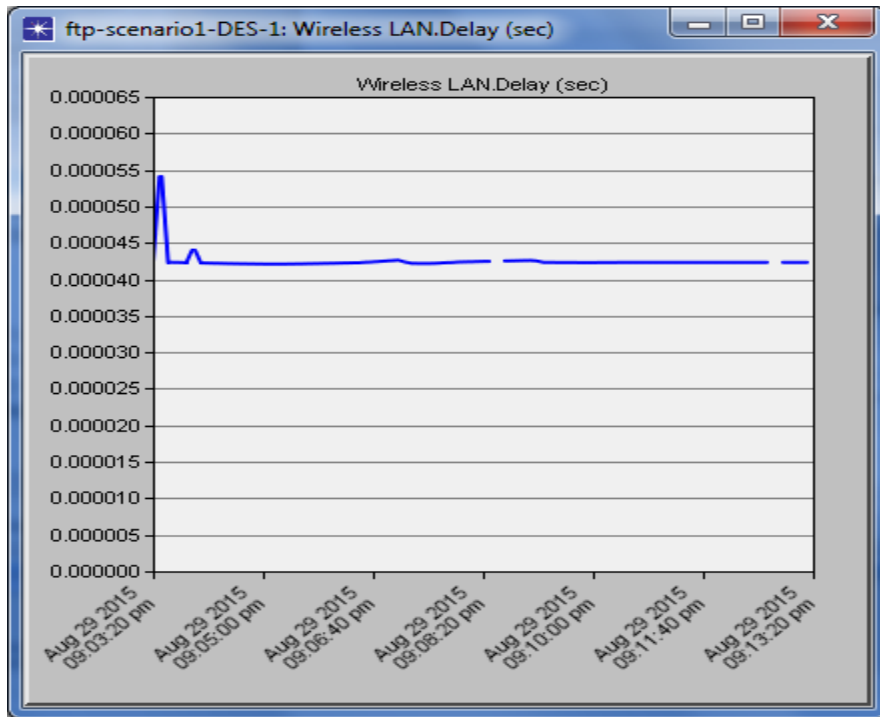

Figure 4.21: Wireless LAN Delay In Sec, In HTTP Scenario

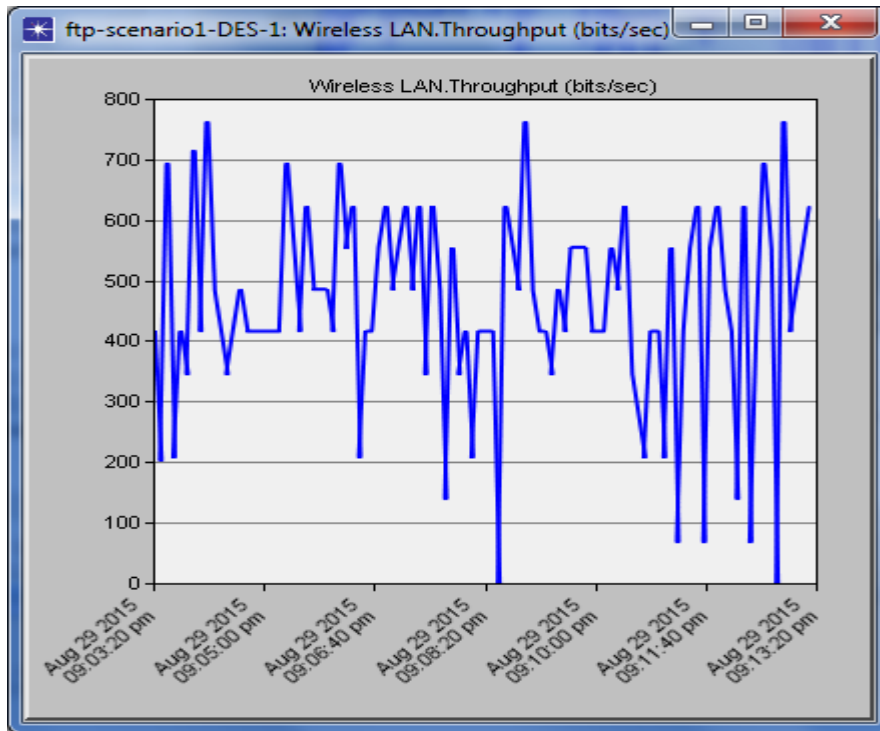

Figure 4.22: Wireless LAN Throughput (bits/sec) In HTTP Scenario

### 4.3.3 Scenario 3 : Extended large Scenario Analysis

Figure 4.23 , shows the average (in Wireless LAN Delay) resulted from using our fast handoff approach in large wireless network . Average LAN delay is less than 3.5 ms .

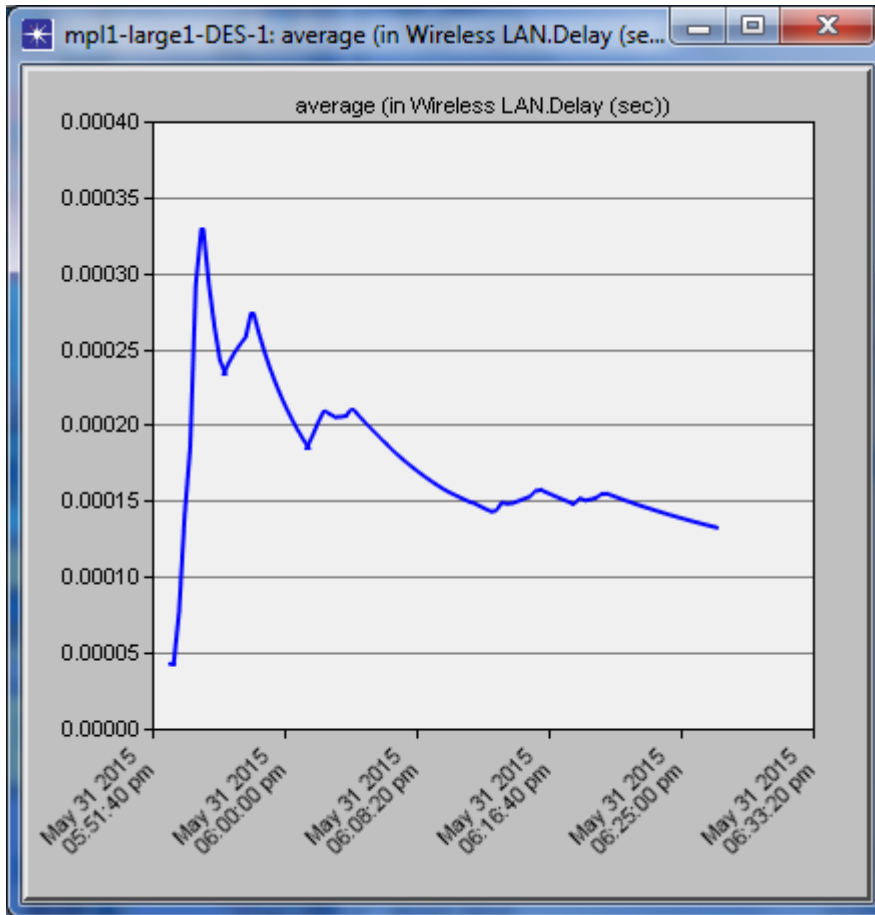
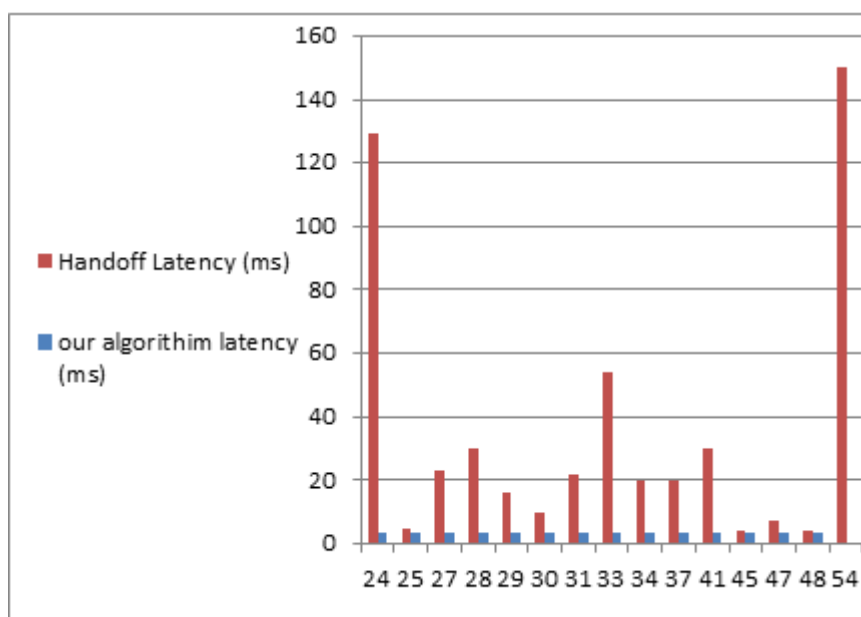

Figure 4.23: Average (in Wireless LAN Delay) In Extended large Scenario

## 4.4 Comparison with other works

Figure 4.24 , shows the some related works algorithms and its resulted of handoff latency comparison with our algorithm handoff latency resulted . X-axis referred to algorithms in chapter two. Our algorithm has got best values than some of previous algorithms in related work



**Figure 4.24: Comparison of Handoff Latency of the proposed algorithm with other algorithms in related work in Chapter Two**

# Conclusion And Future Work



In this thesis, a horizontal handoff between IEEE 802.11 wireless access points is investigated. We mainly focus on the horizontal handoff decision in wireless networks and to provide highest QoS and lowest handoff latency.

After we reviewed the introduction about wireless networks, we dealt with the handoff process in the network that resulted from a mobile movement between access points. Handoff process divided into three phases: scanning phase, authentication phase and re-association. During related work showing that over 90% of the total handoff delay consuming in scanning delay, while (re)association time consumes only a few milliseconds.

We proposed a fast handoff decision schema which depend on three parameter location of mobile, packets reception power threshold and ground speed. Our proposed algorithm, made the mobile to get information about next access point before triggering threshold, which contribute in decreasing probe delay.

We used OPNET 14.5 simulator "Graphical User Interface" to simulate three scenarios: VoIP scenario to emulate real-time traffic as the application that uses UDP, Http scenario to emulate non-real-time traffic as the application that uses TCP and Case Study: Extended large networks to take real measurements.

Simulation results show that the fast handoff decision schema reduces a handoff delay for a few ms less than 3 ms in VoIP application and maintain continuously connection. When we consider a large network size, we measure the average delay which is less than 3.5 ms.

Simulation results also, show improvements in QoS for VoIP application and demonstrate that the proposed fast handoff decision scheme performs well with respect to handoff delay, throughput, jitter, MOS and end to end delay.

For future work, we plan to make a real application on Android devices indoor building . Furthermore, we also plan to study fast handoff in an outdoor WLAN environment. Also we plan to study vertical handoff between two different wireless networks or more.

In this thesis, we only consider the infrastructure mode between the mobile and the access point. We plan to design a distributed handoff scheme that include both infrastructure and ad-hoc mode in indoor and outdoor WLAN environments .

# References

- [1] The Working Group for WLAN Standards " IEEE 802.11TM Wireless Local Area Networks". [Http://www.ieee802.org/11/](http://www.ieee802.org/11/), November 2015.
- [2] Wireless MAN standards for Wireless Metropolitan Area Networks " The IEEE 802.16 Working Group on Broadband Wireless Access Standards". [Http://www.ieee802.org/16/](http://www.ieee802.org/16/), November 2015.
- [3] Dr Shane Rooney "The Mobile Broadband Standard." [Http://www.3gpp.org/](http://www.3gpp.org/), November 2015.
- [4] Norbert Niebert, Andreas Schieder, Henrik Abramowicz, Christian Prehofer and Holger Karl, " Ambient Networks: An Architecture for Communication Networks Beyond 3G " IEEE Wireless Communications, Vol.11, 2004.
- [5] Ahmed H.Zahram, Ben liang and Aladdin Dalch, " Signal threshold adaptation for vertical handoff on heterogeneous wireless networks ", ACM/Springer Mobile Networks and Applications (MONET) journal, Vol.11, No.4, pp 625-640,August 2006.
- [6] Danial M. Dobkin " RF engineering for Wireless Networks, Hardware, Antennas and Propagation". Published by Elsevier Inc. 2005.
- [7] IEEE 802.11 WG, Draft Supplement to Standard For Telecommunications and Information Exchange Between Systems-LAN/MAN Specific Requirements -Part 11: " Wireless Medium Access Control (MAC) and physical layer (PHY) specifications ": Medium Access Control (MAC) Enhancements for Quality of Service (QoS), IEEE 802.11e-D13.0, July.2005.
- [8] 802.11 WLAN Roaming and Fast-Secure Roaming on CUW, November 2015. [Http://www.cisco.com/c/en/us/support/docs/wireless-mobility/wireless-lan-wlan/116493-technote-technology-00.html](http://www.cisco.com/c/en/us/support/docs/wireless-mobility/wireless-lan-wlan/116493-technote-technology-00.html).

[9] Wi-Fi Maps.com War driving Maps and Hotspot Locator, November 2015.  
[Http://www.wifimaps.com](http://www.wifimaps.com).

[10] Pramod Goyal, and S. K. Saxena " A Dynamic Decision Model for Vertical Handoffs across Heterogeneous Wireless Networks" World Academy of Science, Engineering and Technology – (2008).EMY.

[11] R.Chakravorty, P.Vidales, K.Subramanian, L.Pratt, and J.Crowcroft, "Performance Issues with Vertical Handovers- Experiences from GPRS Cellular and WLAN Hot-spots Integration", IEEE Annual Conference on Pervasive Computing and Communications (PERCOM) 2004.

[12] IEEE 802.11, "Part 11: Wireless LAN medium access control (MAC) and physical layer (PHY) specifications, " IEEE Standard 802.11, August . 1999.

[13] Mishra, A Shin, and W. Arbaugh, " An Empirical Analysis of the IEEE 802.11 MAC Layer Handoff Process," ACM SIGCOMM Computer Comm. Rev., vol. 33, no. 2, April. 2003.

[14] M. Fatih and H. Mantar " Access point selection and reducing the handoff latency to support VoIP traffic " 2010.

[15] M. S. Gast, " 802.11 wireless networks, the definitive guide, " O'Reilly & Associates, USA, 2002, pp. 114-137.

[16] Ping-Jung Huang; Yu-Chee Tseng; Kun-Cheng Tsai; "A Fast Handoff Mechanism for IEEE 802.11 and IAPP Networks" Vehicular Technology Conference, 2006. VTC 2006-Spring. IEEE 63rd Volume 2, 2006 Page(s):966 – 970.

[17] R. Koodli. "Fast Handovers for Mobile IPv6". IETF Internet Draft, October.2003. Work in Progress.

[18] MOTOROLA Labs Paris in collaboration with INRIA PLANETE Team, MobiWan: "NS-2 extensions to study mobility in Wide-Area IPv6 Networks".  
<http://www.inrialpes.fr/planete/mobiwan/>.

[19] "NO Ad-Hoc Routing Agent (NOAH) ", November 2015.  
<http://icapeople.epfl.ch/widmer/uwb/ns-2/noah/>.

[20] G. Dommety et al. "Fast Handovers for Mobile IPv6, " Internet Draft, IETF, March 2002.

[21] S. Thomson and T. Narten, "IPv6 stateless address auto configuration, " RFC 2462, IETF, December.1998.

[22] H. Velayos and G. Karlsson, . " Techniques to Reduce IEEE 802.11b MAC Layer Handover Time, " . KunglTekniska Hogskolen, Stockholm, Sweden, Tech. Rep. TRITA-IMIT-LCN R 03:02, ISSN 1651-7717, ISRN KTH/IMIT/LCN/R-03/02.SE, April.2003.

[23] M. Shin, A. Mishra, and W. Arbaugh, " Improving the Latency of 802.11 Hand-offs using Neighbor Graphs, " Proc. ACM MobiSys 2004, June.2004.

[24] S. Shin et al., " Reducing MAC Layer HandoffLatency in IEEE 802.11 Wireless LANs, " Proc. ACM MobiWac 2004, October . 2004.

[25] S.-H. Park, H.-S. Kim, C.-S. Park, J.-W. Kim, and S.-J. Ko, " Selective Channel Scanning for Fast Handoff in Wireless LAN using Neighbor Graph " in Lecture Notes in Computer Science In Personal Wireless Communications: IFIP TC6 9th International Conference ,vol. 3260, pp. 194-203, 2004.

- [26] I. Ramani and S. Savage, " SyncScan: Practical Fast Handoff for 802.11 Infrastructure Networks, " Proc. IEEE Info.com 2005, May. 2005.
- [27] V. Brik, V. Mishra, and S. Banerjee, " Eliminating Handoff Latencies in 802.11 WLANs using Multiple Radios: Applications, Experience, and Evaluation, " Proc. ACM Internet Measurement Conf. 2005, October. 2005.
- [28] Zhang Y, Liu Y, Xia Y, et al. Leapfrog: " Fast, timely wifi handoff. " Global Telecommunications Conference, 2007. GLOBECOM'07. IEEE. IEEE, pp.5170-5174, 2007.
- [29] G. Singh, A. Atwal and B. Sohi, " Effect of Background Scan on Performance of Neighboring Channels in 802.11 Networks" International Journal of communication Networks and Distributed Systems, vol. 1, no. 1, 2008.
- [30] S. Jin, M. Choi, and S. Choi, " Multiple WNIC-Based Handoff in IEEE 802.11 WLANs "IEEE Communications Letters 2009.
- [31] M. Yoon, K. Cho, J. Ji. Li, M. Yun, Y. Yoo, Q. Kim, J. Shu, and K. Yun, " Adaptive Scan: The fast layer-2 handoff for WLAN " in Proc. 8th Int. Conf. Inf. Technol., New Gen., April. 2011, pp. 106–111.
- [32] V. M. Chintala and Q. Zeng, " Novel MAC layer handoff schemes for IEEE 802.11 wireless LANs " in Proc. IEEE WCNC, Mar. 2007, pp. 4435–4440.
- [33] Saxena, N., and Roy, A. " Novel framework for proactive handover with seamless multimedia over WLANs " Communication, IET, Suwon, South Korea, pp. 1204-1212, Jun. 2011.

[34] S. Pack and Y. Choi, " Fast Handoff Scheme based on Mobility Prediction in Public Wireless LAN Systems" IEE Proc. Commun., vol. 151, no. 5, October. 2004, pp. 489–95.

[35] D. Lee, D. Won, Md. Piran and D. Suh, " Reducing Handover Delays for Seamless Multimedia Service in IEEE 802.11 Networks" ELECTRONICS LETTERS, vol. 50, no. 15, pp. 1100-1102, july.2014.

[36] Arunesh Mishra, Minho Shin, William Arbaugh: " Context Caching using Neighbor Graph for Fast Handoffs in a Wireless Network " : INFOCOM 2004. Twenty-third Annual Joint Conference of the IEEE Computer and Communications Societies,

[37] Sangheon Pack, Hakyung Jung, Taekyoung Kwon, and Yanghee Choi: " A Selective Neighbor Caching Scheme for Fast Handoff in IEEE 802.11 Wireless Networks". 2005.

[38] R. Gandhi; " Tolerance to Access-Point Failures in Dependable Wireless Local-Area Networks " Proceedings of the Ninth IEEE International Workshop on Object-Oriented Real-Time Dependable Systems; 2004.

[39] J. C. Bicket, D. Aguayo, S. Biswas, and R. Morris, " Architecture and evaluation of an unplanned 802.11b mesh network "in MOBICOM, 2005, pp. 31–42.

[40] V. Navda, A. Kashyap, and S. R. Das, "Design and evaluation of Mesh: an infrastructure-mode wireless mesh network," in Proc. Sixth IEEE International Symposium on a World of Wireless Mobile and Multimedia Networks (WoWMoM), June.2005, pp. 164–170.



[41] Shantidev Mohanty, Ian F. Akyildiz, "A Cross-Layer (Layer 2 + 3) Handoff Management Protocol for Next-Generation Wireless Systems," IEEE Transactions on Mobile Computing, vol. 5, no. 10, pp. 1347-1360, October.2006.

[42] Dutta, Ashutosh; Madhani, Sunil; Wai Chen; Altintas, Onur; Schulzrinne, Henning; , "GPS Assisted Fast-Handoff Mechanism for Real-Time Communication," Sarnoff Symposium, 2006 IEEE , vol., no., pp.1-4, 27-28 March 2006.

[43] Jang-Sub Kim, Erchin Serpedin, Dong-Ryeol Shin, and Khalid Qaraqe, "Handoff Triggering and Network Selection Algorithms for Load-Balancing Handoff in CDMA-WLAN Integrated Networks", Hindawi Publishing Corporation EURASIP Journal on Wireless Communications and Networking Volume 2008.

[44] Jung-Min Moon, Dong-Ho Cho, " Efficient handoff algorithm for inbound mobility in hierarchical macro/femto cell networks " IEEE Communications Letters, vol.13, no.10, pp. 755-757, 2009.

[45] Wu Shaohong, Zhang Xing, Zheng Ruiming, Yin Zhiwei, Fang Yinglong ,Yang Dacheng, " Handover Study Concerning Mobility in the Two- Hierarchy Network " IEEE 69th VTC Spring 2009, pp.1-5, 2009.

[46] Z. Zhang, R. W. Pazzi, and A. Boukerche, " A mobility management scheme for wireless mesh networks based on a hybrid routing protocol, " Comput. Netw., vol. 54, no. 4, pp. 558–572, March . 2010.

[47] Koushik Kumar Nundy, Himanish Mukherjee, Debabrata Sarddar, M. K. Naskar, U.Biswas, " Minimisation of Hand-off Failure Probability and False Hand-off Initiation in Low Latency Next Generation Wireless Networks " , Int. Jnl. of Information Technology and Knowledge Management, Vol 3 No 1, Jan-Jul 2010.

[48] A. Boukerche, Z. Zhang, and X. Fei, " Reducing handoff latency for NEMO-based vehicular ad hoc networks," in Proc. IEEE GLOBECOM, 2011, pp. 1–5.

[49] H. Li, J. Xie, and X. Wang, " A channel splitting strategy for reducing handoff delay in Internet-based wireless mesh networks "IEEE Trans. Veh. Technol., vol. 61, no. 6, pp. 2740–2752, July. 2012.

[50] V. Saravanan, A. Sumathi " Location and Priority based vertical handoff approach for seamless mobility" International conference on current trends in Advance computing (ICCTAC) 2013.

[51] Wei-Cheng Xiao, Shih- Hsuan Tang, " A Novel seamless vertical handoff solution. "IEEE PIMRC, vol 2.pp 765, 2013.

[52] Yong Sun, Weill Li, " A novel fuzzy logic based Vertical handoff Decision Algorithm for heterogeneous wireless Network " IEEE international conference on smart communication protocols and algorithms, 2013.

[53] S. Kunarak, R. Sulesahira, E. Dtkiewicz, " Vertical Handoff with Predictive RSS and Dwell Time, " IEEE Region 10 Conference, 2013.

[54] Nidhi Sanghavi & Rajesh S. Bansode "Improving IEEE 802.11 Wlan Handoff Latency by Access Pointbased Modification" Global Journal of Computer Science and Technology: E Network, Web & Security Volume 15 Issue 5 Version 1.0 Year 2015.

[55] OPNET 14.5 Modeler Documentation, was created by OPNET Technologies. It is supported by any Windows OS..